

Wireless World

RADIO AND ELECTRONICS

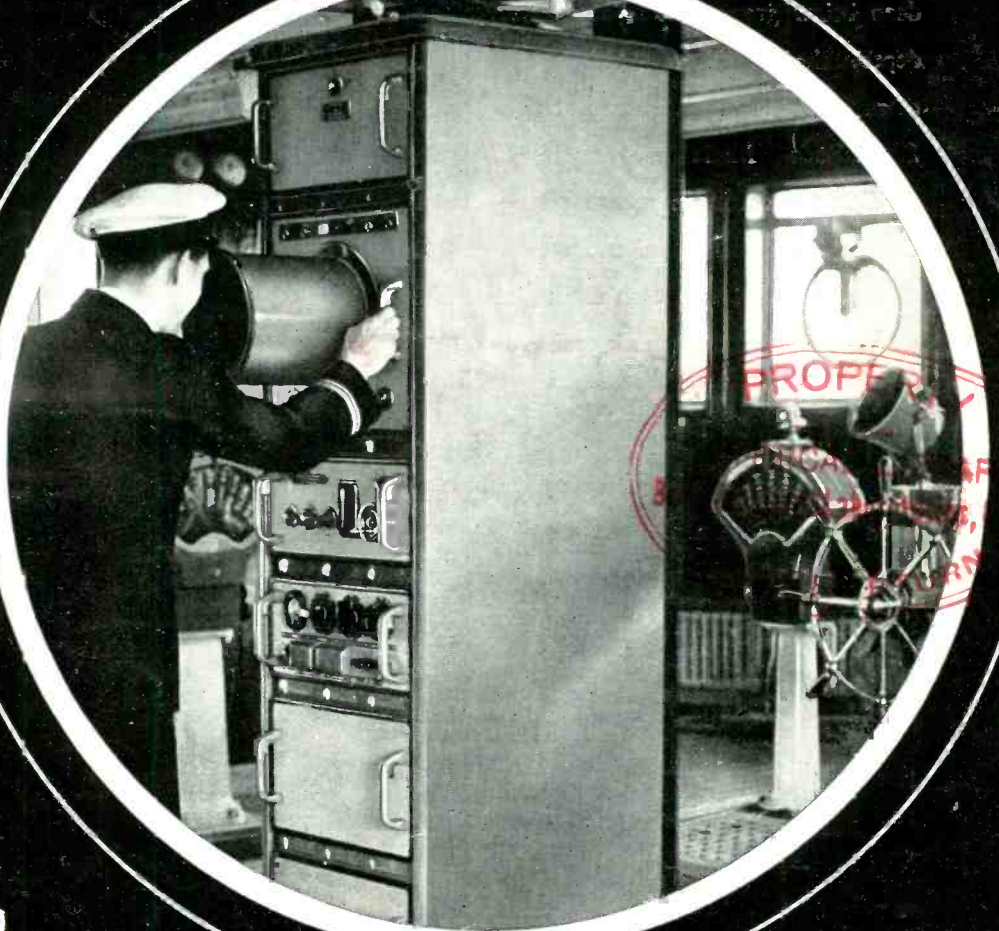

SL
9/15
IF UN
PLEASE FL

SEPT. 1947

1/6

Vol. LIII. No. 9

IN THIS
ISSUE :

BROADCAST RECEIVING AERIALS

B.I. Callender's Extensible Copper EARTH ROD

Strata of low resistivity are often deep below ground level, but whatever the depth, the simplest method of reaching them is to use B.I. Callender's Extensible Earth Rods. Made in 4 feet lengths from $\frac{3}{8}$ " diameter corrosion resisting hard drawn Copper, fitted with hardened steel tips and driving caps and joined on site by phosphor bronze screws, these rods can be driven deep into undisturbed soil. Installation costs are low, no excavation being necessary. Deepest penetration is possible by the use of a light mechanical hammer; a 4 lb. hammer will drive the rods to moderate depths in any soil reasonably free from rock or stone. The rod head is sunk below ground level and there protected in a concrete housing, making regular inspection possible and minimising surface potential gradients. Write to-day for B.I. Callender's free publication No. 213Y, "Earthing."



BRITISH INSULATED CALLENDER'S CABLES LIMITED
 NORFOLK HOUSE, NORFOLK STREET, LONDON W.C.2



AVO
 REGISTERED TRADE MARK

MODEL 7
 UNIVERSAL
 Avometer

MODEL 40
 UNIVERSAL
 Avometer

THE AVO
 TEST
 SET
 82120

THE AVO
 VALVE TESTER

THE
 AVO
 DECELERATOR

RAUDIO manufacturers, service engineers, workshop and laboratory technicians are familiar with the precision and dependability of "AVO" Electrical Testing Instruments. Long years of successful experience in the design and manufacture of first-grade instruments have produced a consistently high standard of accuracy which has become a tradition as well as a standard by which other instruments are frequently judged.

THE AUTOMATIC COIL WINDER & ELECTRICAL EQUIPMENT CO., LTD.
 WINDER HOUSE DOUGLAS STREET LONDON S.W.1 TELEPHONE VICTORIA 5404/7



PIFCO

ALL-IN-ONE RADIOMETER

tests everything electrical, Radio and P.A. Equipments, Household appliances of all kinds, Car Lighting Systems, Bell and Teleprinter Circuits. May be used on AC or DC mains.

25/-

Still in short supply but ask your Local Dealer to put your name down on his waiting list.

The SHERLOCK HOLMES OF RADIO SINCE 1930



Model P84. An 18" diameter Speaker with a peak power handling capacity of 40 Watts; suitable for public address purposes.

Model P₂VO. A 2½" diameter Speaker, weighing only 3½ ozs., designed for small personal radios.

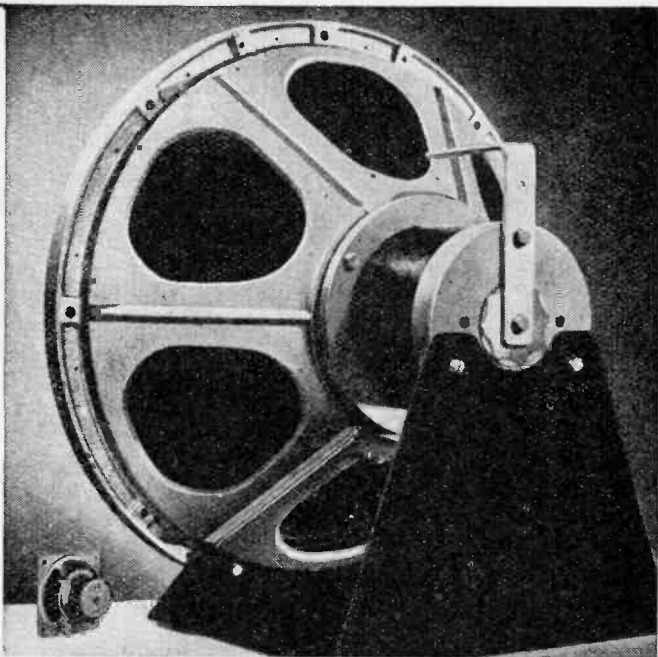

CELESTION LTD

KINGSTON-ON-THAMES, SURREY

TELEPHONE: KINGSTON 5656-7-8-9

STAR PERFORMANCE



MAZDA

RADIO VALVES AND CATHODE RAY TUBES

THE EDISON SWAN ELECTRIC COMPANY LTD.  155, CHARING CROSS ROAD, LONDON, W.C.2

PLOTTING THE COURSE

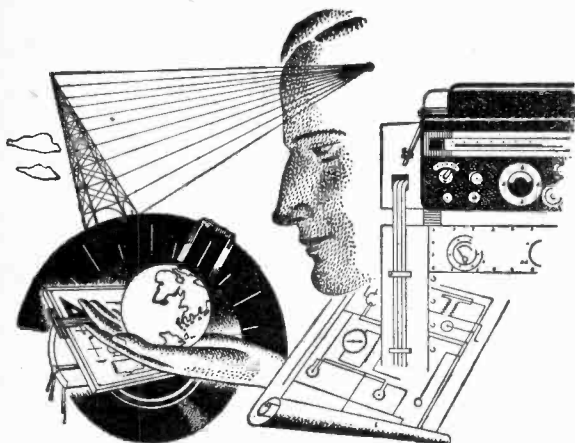

IN TOMORROW'S WORLD

In the world of to-morrow, as in the world of yesterday and to-day, Marconi's will carry forward the tradition of meticulous workmanship in communications apparatus.

New problems have been met as they have arisen by a team of experts with all the experience of a pioneer organisation behind them. Still newer problems are now arising in a post-war world. These too will be handled with the same resourceful skill. Whatever the demands of a new age—you know where you are with Marconi.

MARCONI

THE GREATEST NAME IN WIRELESS



MARCONI'S WIRELESS TELEGRAPH COMPANY LTD
THE MARCONI INTERNATIONAL MARINE
COMMUNICATION COMPANY LTD
MARCONI HOUSE, CHELMSFORD, ESSEX



A Growing Audience

MORE AND MORE people are enjoying good radio entertainment through the smooth power provided by Pertrix accumulators. Every Pertrix product gives a consistently high performance—just a little more than the promise. For trouble-free listening choose the accumulator in the red and yellow pack. Most good dealers stock them.

HOLSUN BATTERIES LTD.

137 Victoria Street, London, S.W.1

Mica has many *advantages*

Meet us at
RADIOLYMPIA
OCT 1-11

STAND No. 5

TCC

has *All* the *advantages*

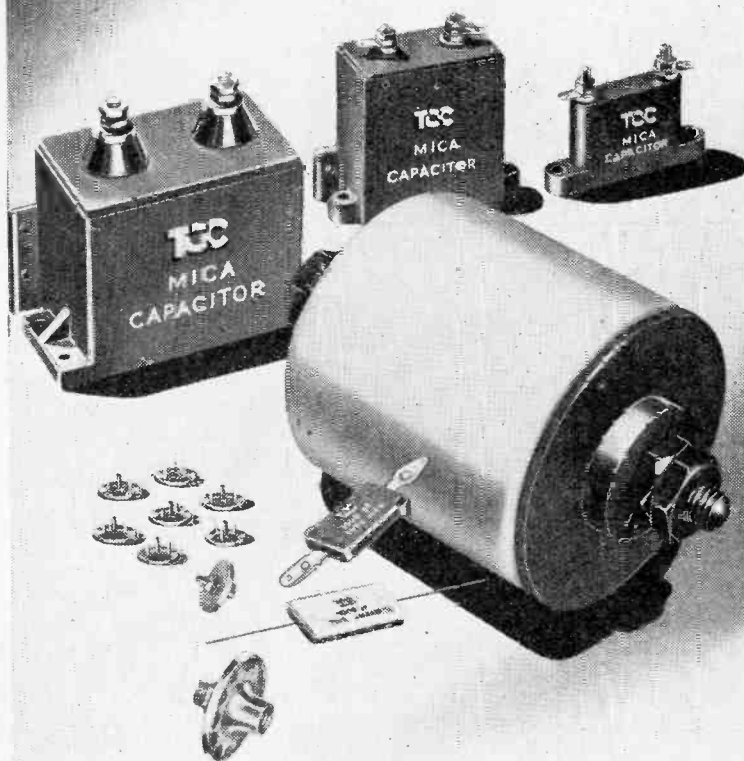

Mica is an excellent insulating material and has other properties which render it highly suitable as a capacitor dielectric for use in radio frequency circuits, especially where large amounts of power are handled.

In T.C.C. Mica Capacitors, the natural advantages of carefully selected high grade dielectric are enhanced by sound design and construction resulting in superior electrical performance of the highest reliability. The T.C.C. range is extremely comprehensive, comprising Receiver types in moulded stacked foil, moulded silvered and protected silvered varieties, also Transmitter type in moulded bakelite cases or porcelain pots.

In the Best Sets you'll see TCC

THE TELEGRAPH CONDENSER CO. LTD.

RADIO DIVISION

NORTH ACTON · LONDON · W.3

TELEPHONE: ACORN 0061



Your designs

LET US BRING THEM TO

LIFE!

Made in Three Principal Materials

FREQUELEX

An Insulating material of Low Di-electric Loss, for Coil Formers, Aerial Insulators, Valve Holders, etc.

PERMALEX

A High Permittivity Material. For the construction of Condensers of the smallest possible dimensions.

TEMPLEX

A Condenser material of medium permittivity. For the construction of Condensers having a constant capacity at all temperatures.

the most difficult problems solved by . . .



Bullers

BULLERS LOW LOSS CERAMICS

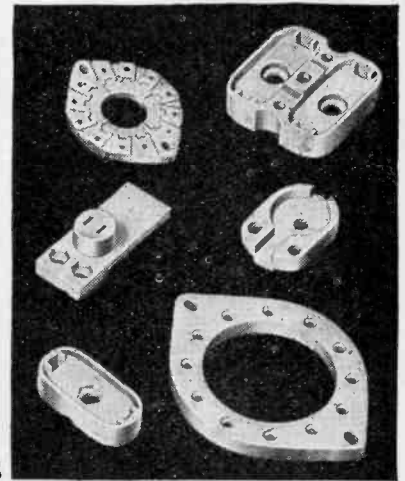

BULLERS LTD., 6, LAURENCE POUNTNEY HILL, LONDON, E.C.4

Telephone: Mansion House 9971 (3 lines)

Telegrams: "Bullers, Cannon, London"



FOR THE RADIO SERVICEMAN DEALER AND OWNER

The man who enrolls for an I.C.S. Radio Course learns radio thoroughly, completely, practically. When he earns his Diploma, he will KNOW radio. We are not content merely to teach the principles of radio, we want to show our students how to apply that training in practical, every-day radio service work. We train them to be successful!

Write to the I.C.S. Advisory Dept. stating your requirements. Our advice is free and places you under no obligation.

-----You may use this coupon-----

INTERNATIONAL CORRESPONDENCE SCHOOLS Ltd.

DEPT. 38, INTERNATIONAL BUILDINGS, KINGSWAY, LONDON, W.C.2

Please explain fully about your instruction in the subject marked X

Complete Radio Engineering Radio Service Engineering
Elementary Radio

And the following Radio Examinations:—

British Institution of Radio Engineers
P.M.G. Certificates for Wireless Operators
City and Guilds Telecommunications
Wireless Operators and Wireless Mechanics, R.A.F.

Name..... Age.....

Address.....

M. R. SUPPLIES Ltd.

Some first-class new offers by this old-established house. Our discriminate buying is your guarantee of satisfaction. Immediate despatch. All prices nett.

MICRO-AMMETERS, Grade 1 m/coil, by prominent British makers. Deflection 0/100 micro-amps. Int. resistance 600 ohms. 2 1/2 in. flush panel mtg., brand new in makers' boxes. 27/6.

ATTENUATORS (Palatoo) Precision, wire-wound, screened, with 1-inch spindle. Centre-tapped potentiometers. 1600 ohms in 20 x 80-ohm taps, 10/6. 50 ohms in 20 4-ohm taps, 10/6. 3000 ohms in 40 75-ohm taps, 14/6.

POWER TRANSFORMERS (New, ex Admiralty) Prim: 280 v., Sec: 500/0/500 v. 170 m.a. (350 m.a. can be safely drawn), 4 v. 4 a., C.T., Weight 16 1/2 lbs. 37/6 (Desp. 2/11a, 2/6.)

P.A. SPEAKERS, Witavox 10-watt P.M. Pressure Unit (15 ohms coil) fitted to 30 inch all-metal Projector Horn, 29 1/2 in. O. (Desp. 5/-)

STEEL TRIPODS to suit above and all other P.A. Speakers, collapsing to about 5ft. and ext. to 12ft. We are told that this is the best type ever made—perfectly rigid under gale conditions. 55/- (Desp. 3/6.)

VENER TIME SWITCHES (Process Timers.) All-brass out-gearred spring-driven movement automatically rewound every eight hours by mains. Pulsing 4-second closed circuit every one (or two) minutes. Precision made for Admiralty use. In weather-proof die-cast housing, 9 by 6 by 4 1/2 in. The rewind motor is for 100 v. D.C. but we supply (16/6 extra) suitable rectifier gear for any A.C. mains operation. A very limited supply of the Timers, brand new, at £5 each (Desp. 2/-).

RESISTANCE BOXES, Decade type. Units 0/10 ohms. Tens 0/100 ohms, with additional 100 ohms. Fitted m/coil Galvo. Switching for Wheatstone Bridge and other tests. Very fine instruments in teak case, 16 by 7 1/2 by 6 in. Brand new, 65/- (Desp. 2/6.)

MINIATURE GOVERNED MOTORS with constant speed slip-ring device. 24 v. D.C. Speed 2,750 r.p.m. With rectifier quenching system. In metal case 3 1/2 in. sq. by 2 1/2 in. (These precision instruments cost Govt. £19/10/- each). Brand new, 25/-.

SMALL UNIVERSAL L.V. MOTORS, 24 v. AC/DC (operating very well on 12 v. D.C.) Length 3 1/2 in. width 2 1/2 in. Series wd., ball bearing, 1 1/2 in. spindle. Ideal for cine, laboratory stirrers, fans, etc., exceptional offer, only 17/6 each.

DC/AC CONVERTERS, newest Vibrator type, for radio and television, amplifiers, etc. Silent and utterly reliable. 200/240 v. D.C. to 200/240 v. A.C. 50 c., 200-watt £12 (desp. 3/-); 100-watt, £9 (Desp. 2/-).

NOTE—If for television we recommend the 75 cycle model, 200-watts, same price. **LOCAL VOL. CONTROL UNITS**, wire-wound 100-ohms potentiometer with separate on-off switch, in metal housing 3 1/2 by 2 by 3 1/2 in. These well-made units are ideal for vol. control of extension speakers, 6/6.

H.V. CONDENSERS, 1.5 mfd., 4,000 v. wkg. Insulated terminals, 12/6.

PANEL METERS (AC/DC) Good quality M/Iron, 3 1/2 in. prof. mtg. with back terminals following range:—Amps, 0/5, 0/10 and 0/25. Volts, 0/20 and 0/40. Any one, 29/6.

HAND BEARING COMPASSES, type 06A. Prismatic, alcohol floated. Dia. 3 1/2 in. Torch illuminated (battery not supplied). Overall length 8 1/2 in. In wooden transit case. Fine condition, as new, £31/7/6 (Desp. 2/-).

S.T.C. TOGGLE PRESSES (We are London Stockists). Double-acting, space-saving, precise tool suitable for pressing operations in many trades. Senior, pressure 1 1/2 tons, £31/10/- Minor, pressure 0.75 ton, £24/15/-, ex this address.

We hold large stocks of Transformers, Rheostats, Rectifiers, Measuring Instruments, Electric Pumps, Extractor Fans, Amplifiers, etc. Please include sufficient for packing and despatch.

M. R. SUPPLIES LTD., 68, New Oxford Street, London, W.C.1

Telephone: MUScum 2958

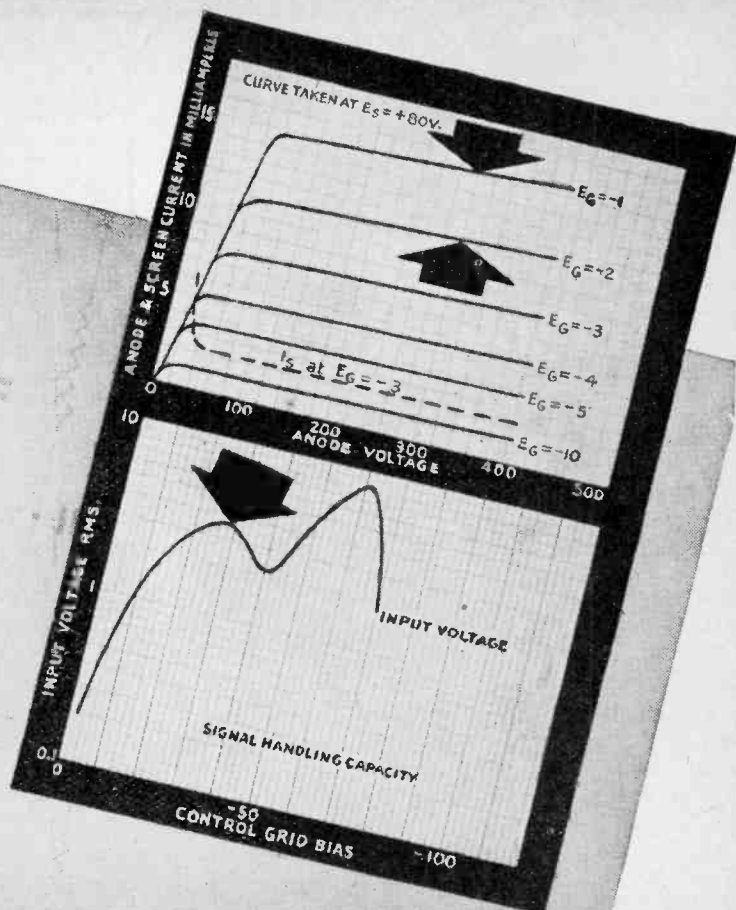

POINTERS FOR DESIGNERS

THE KTW61

A screened tetrode with suppressor plates and with variable-mu characteristics, the OSRAM KTW61 is specially suitable for use as an R.F. or I.F. amplifier in superhet receivers. Its outstanding features include:—

- High order of mutual conductance (2.9 mA/Volt) combined with low leakage capacitance (0.0025 μF), which facilitates high stage gain.
- Negligible distortion with the maximum signal likely to be encountered in practice. Conditions of use — as an I.F. amplifier with screen dropping resistance, and in conjunction with OSRAM frequency changer X61M.
- Marked improvement in signal to noise ratio, particularly on the short waves, when used as an R.F. amplifier with fixed screen voltage.

A detailed technical data sheet is available on request.

Osram
PHOTO CELLS

G.E.C.
CATHODE RAY TUBES

Osram
VALVES



We at Redifusion try to be modest, but we really must tell you this story.

A man came in to see us the other day—said he had an airport and that he wanted some wireless for it. So we asked him why he had come to us and he replied that he liked our up-and-coming youthfulness, and that when up-and-coming youth enters a business like the communications field—well, they've just got to be good.

"Youth!" we exclaimed, "We've been turning out first-class communications gear for over ten years."

"That's young enough for my money," he replied, "When can I have delivery?"

Here's a picture of our Redifon G40, a 500/800 watts M.C.W. and Telephony transmitter which is suitable for ground/aircraft communications services, Navigational Radio Beacons for airways and sea routes, and broadcasting on medium and short waves.

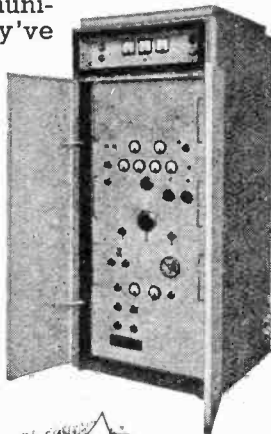

Redifon RADIO

Communications Division
REDIFFUSION LTD., BROOMHILL ROAD, S.W.18
 Designers and Manufacturers of Radio Communication and Industrial Electronic Equipment. Scientific RC102

**We don't sell
 Transformers
 "OFF THE SHELF."**

There is nothing "ready-made" about SAVAGE Transformers. We build any model up to 5kVA to suit your exact requirements. This may mean a little extra trouble at first, but it is your guarantee that the finished article will fit into your production with the greatest possible efficiency.

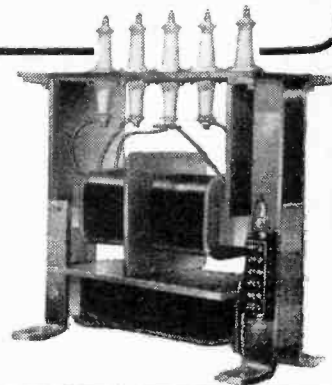

"PURPOSE-BUILT"
Savage
TRANSFORMERS LTD.
 51, NORTHGATE STREET, DEVIZES. Phone 536

RADIOGRAM

By every test—proved the best

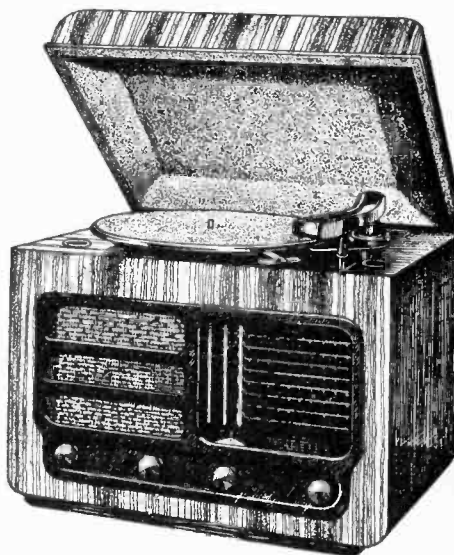

AMBASSADOR

A new listening thrill... engineering's most brilliant achievement—Ambassador Radiogram—**£36-6-8**
 Unequalled for specification and value.

Write for Illustrated Leaflet.

**AMBASSADOR RADIO WORKS
 HUTCHINSON LANE, BRIGHOUSE, YORKS.**

HIGH STABILITY RESISTORS

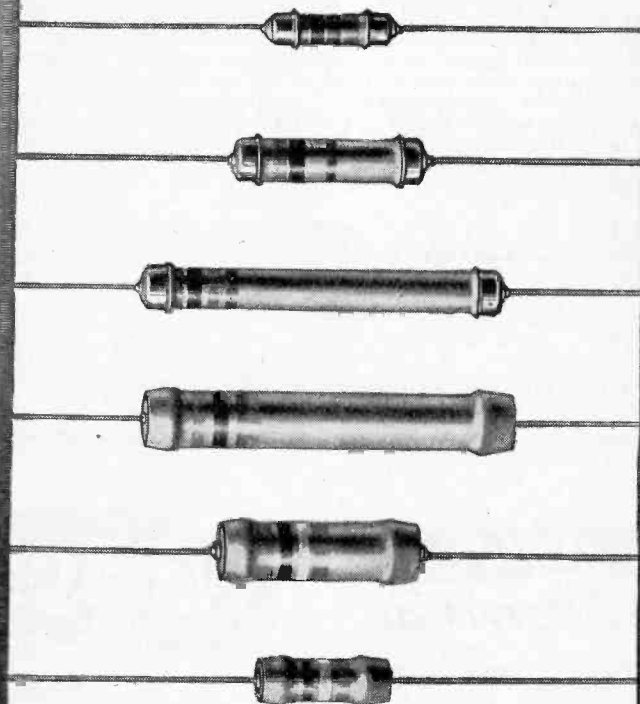

DUBILIER
CONDENSER CO. (1925) LTD.

WHERE HIGH STABILITY IS ESSENTIAL

For operation in certain special conditions, a high degree of stability is the chief characteristic required of fixed resistors. For example, in television, electronic and instrument applications where maintenance of maximum stability is desired over long periods of continuous use, high stability in resistors must be the primary qualification. The particular process of manufacture to which Dubilier High Stability Resistors are subjected ensures this great stability of resistance value, coupled with a low temperature coefficient of resistance, a negligible voltage-coefficient and a low "noise level".

In all conditions where high stability is vital, a selection from this specially designed range of Dubilier High Stability Resistors type R should be made. Full technical details and prices will be sent upon receipt of your enquiry.

DUBILIER CONDENSER CO. (1925) LTD., DUCON WORKS, VICTORIA ROAD, NORTH ACTON, W.3
 Phone: Acorn 2241. Grams: Hivoltcon, Phone, London. Cables: Hivoltcon, London. Marconi International Code.

D11

B

The Problem

The directional response characteristic of single unit loudspeakers is very pronounced at the higher audio frequencies which are audible only in a comparatively narrow channel directly in front of the reproducer with a corresponding lack of intelligibility and brilliance elsewhere.

This feature is particularly troublesome when high quality sound reproduction is required in public halls, theatres and small cinemas where the size and expense of a large dual channel loudspeaker system is often not justified.

The Solution

It is for such installations that the Vitavox Bitone Reproducer has been designed. High frequency reproduction in this instrument is handled by a small multicellular horn and moving coil pressure unit, this assembly providing adequate coverage and at the same time because of its high efficiency, a rising high note characteristic which is an advantage in auditorium reproduction. A 12" moving coil cone type loudspeaker operating in a vented enclosure reproduces low frequencies and a cross-over filter network is fitted to divide the frequency spectrum correctly between the two units. The whole assembly is mounted in a polished Walnut finished cabinet as standard, Oak and Mahogany veneered models being available to special order, and can be relied upon for applications where quality of performance rather than first cost is the main consideration.

S P E C I F I C A T I O N A N D P R I C E S

Power Handling Capacity: Model 610—10 watts; Model 620—20 watts. Size: 32" x 21" x 20". Terminating Impedance: 7.5 ohms. Filter Attenuation: 12 d.b. per octave. H. F. Distribution (approx): 60° x 40°.

MODEL 610 — £42 0 0
MODEL 620 — £50 0 0

VITAVOX LTD., WESTMORELAND ROAD, LONDON, N.W. 9. TEL: COLINDALE 8671-3



... DEPENDABILITY
is Essential

Reception conditions range from excellent to very poor; signal strength from strong to very weak, and to cope successfully with all such conditions, you need a pair of highly sensitive and dependable headphones.

If you want maximum reception results you should insist that your local dealer supplies you with a pair of the rightly famous S. G. BROWN Type 'F' headphones. Sea, land and air W/T operators, servicemen, experimenters and radio amateurs all vouch for their dependability.

TYPE 'F' (Featherweight)
Price 25/- per pair
YOUR LOCAL DEALER CAN SUPPLY.

Type 'F'

Descriptive Brochure "W.W." gives details of full range. Prices from 25/- up to 105/- for Moving Coil Type 'K'. Brochure "W.W." sent on request.

S.G. Brown, Ltd.

*Phone:
ACOrn
5021

VICTORIA ROAD, NORTH ACTON, LONDON, W.3

Varley
REGD. TRADE MARK

*Products of
Quality & Reliability*

**MAINS TRANSFORMERS
A. F. TRANSFORMERS
SMOOTHING CHOKES
THERMAL DELAY SWITCHES
POWER RESISTANCES**

Made by
OLIVER PELL CONTROL LTD
Telephone - WOOLWICH 1422
CAMBRIDGE ROW · WOOLWICH S·E·18

Webb's

FOR DIVERSITY OF STOCK

**MODERN
GRAMOPHONE
EQUIPMENT**
to be heard in our new
Demonstration Room



1. **Connoisseur Pickup.** A lightweight miniature moving iron Pickup, of high fidelity characteristics. Average output from secondary of Transformer .7 volts. Uses H.M.V. silent Stylus or the equivalent "Connoisseur" needles. Also suitable for use with special thin thorn needles. Sold complete with input Transformer
£3 18 9
2. **Rothermel "Senior" Crystal Pickup.** A recognized standard of comparison for Crystal Pickups. Frequency range 50-7,500 c/s. Average output 1.5 volts. For standard needles £2 16 3
3. **Lexington "Senior" Moving Coil Pickup.** Advanced modern design, incorporating ingenious semi-automatic insertion and rejection of sapphire needles. Given a good Amplifier and Loudspeaker, reproduction is superb
£6 14 6
4. **Wilkins & Wright Type "N" Moving Coil Pickup.** First-class design and engineering. Combines high fidelity with robust construction and reliability. Needle pressure adjustable 1/4 to 1 oz. Uses miniature needles such as "H.M.V. Silent Stylus," "Connoisseur," "W. & W. Ministyle," complete with "Equalizing Transformer" £7 0 7
5. **Lexington Input Transformer.** In mu-metal box for efficient screening. Made especially for Lexington "Senior" and "Junior" Pickups, and also recommended for use with home-made or experimental Moving Coil Pickups £1 14 2

6. **Wearite Type 207 Midget Transformer, Ratio 60/1.** A very useful step-up Transformer, for moving coil Pickup work. Its small size facilitates short wiring in Amplifier 15 0
7. **Wilkins & Wright "Equalizing" Input Transformer,** for use with Wilkins & Wright type "N" Moving Coil Pickup. Incorporates compensating network (sold complete with Wilkins & Wright Type "N" Pickup)
- Wilkins & Wright "Scratch Filter."** A useful low-pass Filter, the top limit being adjustable between 3.5 to 8.5 kc/s (similar in appearance to Equalizer).. £1 16 8
8. **Lexington "Junior" Moving Coil Pickup.** Of similar and general design to the "Senior" model, but without auto-insertion mechanism. Made especially to take miniature needles, "H.M.V. Silent Stylus," etc.
£4 4 8
9. **B.T.H. Magnetic Pickup.** An excellent general purpose moving-iron Pickup, with built-in Volume Control, output approximately .7 volts. Takes all standard size needles £1 13 11
10. **Sound Sale Non-Magnetic Turn-Tables.** Cast in aluminium alloy with stroboscopic markings for 78 R.P.M. Size 12in. diameter, weight 3 lbs. 6 ozs. Replaces the normal steel turn-table on your motor, and eliminates magnetic pull from modern type Pickups
£1 15 0
- Rubber Mats, 12in. diam., for use with non-magnetic, or original turn-tables 7 6

WEBB'S Radio

14, SOHO STREET, OXFORD STREET, LONDON, W.1

Telephone: GERrard 2089. Shop Hours: 9 a.m.—5.30 p.m. Sats. 9 a.m.—1 p.m.

AVAILABLE NOW!

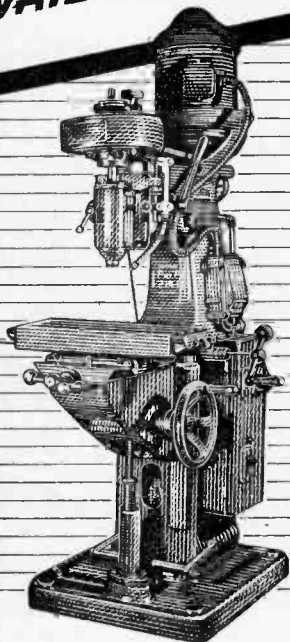

machine tools

OF NUMEROUS TYPES

Government Surplus machine tools available NOW at attractive prices. YOUR opportunity to get better equipment and increase production.

DISPOSAL CENTRES, where records of all machines available may be inspected, are open to the public for enquiries from 10 a.m. to 4 p.m. Monday to Friday inclusive:—

BIRMINGHAM C.M.L. Buildings, Great Charles Street

BRISTOL 8/9 Elmdale Road, Bristol 8.

CARDIFF Imperial Buildings, Mount Stuart Square.

GLASGOW 21 Glassford Street.

LEEDS 10 Bank Street, off Boar Lane.

LONDON Room 0088, Ground Floor, Thames House North, Millbank, S.W.1.

MANCHESTER Britannia House, Fountain Street.

ISSUED BY THE MINISTRY OF SUPPLY

K

Masteradio

VIBRATOR PACKS

Suitable for

- RADIO RECEIVERS AND TRANSMITTERS
- AMPLIFIERS
- PUBLIC ADDRESS SYSTEMS
- SCIENTIFIC APPARATUS
- EMERGENCY POWER SYSTEMS

MASTERADIO LTD., 319/321, EUSTON RD., LONDON, N.W.1

Wharfedale

LOUDSPEAKER SEPARATOR

*Cross-over at 1,000 c.p.s.
Maximum input 30
watts at 3 to 15
ohms impedance*



Size: 8" x 5" x 4"

A new device for dividing the Bass and the Treble between two Loudspeakers at low impedance, thus eliminating modulation distortion imposed on the treble by large coil movement in the bass. It is recommended for use with two speakers of equal sensitivity and similar size. (Not suitable for Horn type speakers).

The Separator results in greater efficiency, stronger top note response and improved clarity of reproduction and extends the range and intelligibility of P.A. speakers.

The impedance of two 3 ohm speakers connected to the Unit becomes 6 ohms, but when two 15 ohm speakers are used the total impedance remains 15 ohms.

PRICE 75/- (Delivery 2/3 weeks)

Made and Guaranteed by

Wharfedale Wireless Works

BRADFORD ROAD, IDLE, BRADFORD

Telephone: IDLE 461.

Telegrams: Wharfedale, Idle, Bradford.

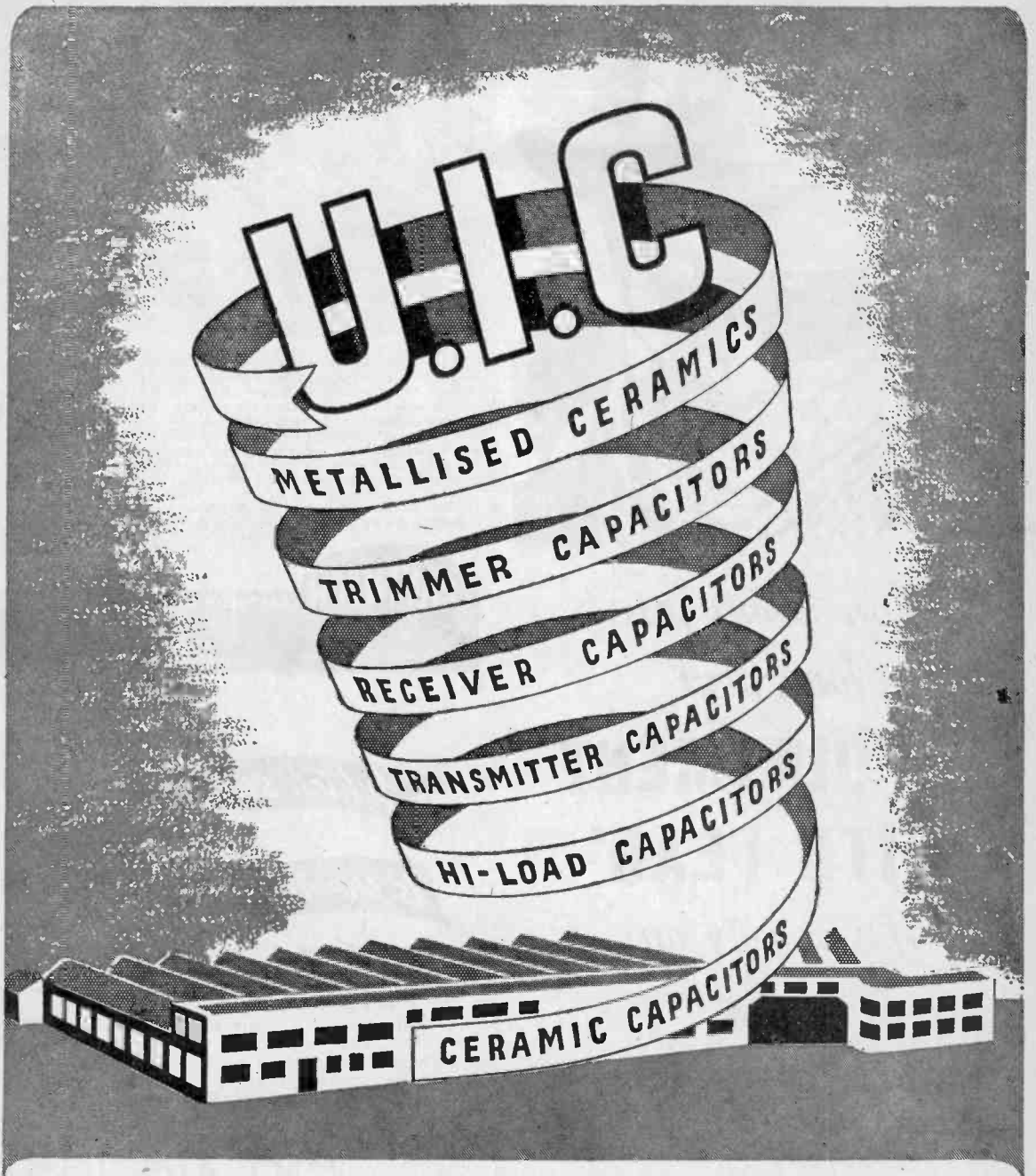

UNITED INSULATOR CO. LTD., OAKCROFT RD. TOLWORTH, SURBITON, SURREY

Telephone: Elmbridge 5241

Telegrams: Calanel, Surbiton

Unsurpassed **I**n **C**eramics



*You won't miss
your next*

**'APPOINTMENT
WITH FEAR'**

if you rely on

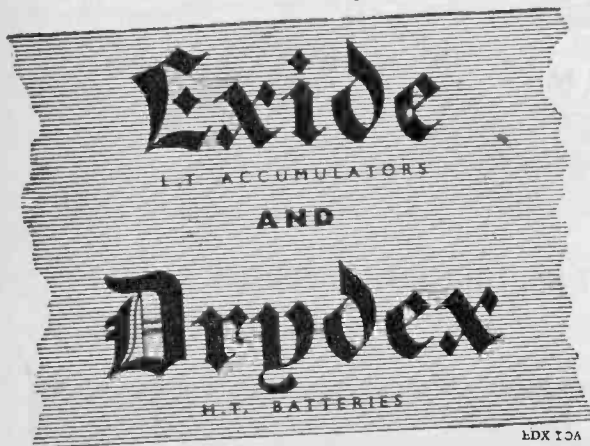

PRODUCTS OF
THE CHLORIDE ELECTRICAL STORAGE COMPANY LIMITED

RAYTHEON CONTRIBUTIONS to development of Hearing Aids

More for the Money

IN HEARING AIDS...

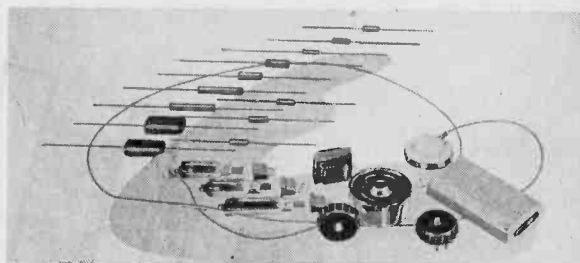

In compactness, ease of control, dependability, economy of operation, convenience of servicing, fidelity of tone, and all-round superiority, the Hearing Aid of today is far bigger value than that of yesterday. A great contribution to this advance is the reduced battery drain, long life, small size and all-round reliability of the Raytheon Flat Hearing Aid Valve. New production techniques and specially designed valve manufacturing equipment which have made this possible are typical of Raytheon service to Hearing Aid makers and users. Another reason why 90% of all Hearing Aid Tubes in use throughout the world today are marked with the name RAYTHEON!

For detailed information on Raytheon Hearing Aid Valves write to Submarine Signal Company (London) Ltd., Artillery House, Artillery Row, London, S.W.1, England, or to:

RAYTHEON

RAYTHEON MANUFACTURING COMPANY
INTERNATIONAL DIVISION

Excellence in Electronics

60 EAST 42nd STREET
NEW YORK 17, N. Y., U. S. A.

*Which Switch
is the right switch?*

... is it Rotary or Pushbutton or Slider? Is it wanted for circuit selection, band selection, tap switching? Is it for a new design or in quantities for a well proved circuit?

Whatever it is — the answer is always OAK!

The basic design of all Oak switches is one of strength and efficient functioning, including such exclusive features as the double-contact clip and the floating rotor, ensuring self-alignment of each section.



AND



OAK SWITCHES

BRITISH N.S.F. CO. LTD., Keighley, Yorkshire
(Sole Licensees of OAK Manufacturing Co., Chicago)

A.B. METAL PRODUCTS LTD., Feltham, Middx.
(Sub-Licensees of N.S.F.)

The only Manufacturers of OAK Switches under Patent
Nos. 478391 & 478392

THE RECTIFIER

with a past performance that guarantees its future

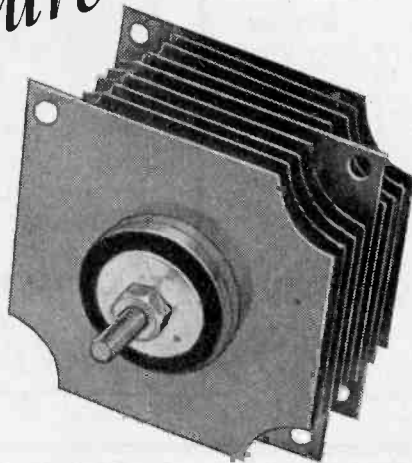

Typical unit for H.T. supply to radio receivers.

The



METAL RECTIFIER

Twenty years past performance has shown that there is no rectifier quite as reliable as Westinghouse. Its robust all-metal construction and high efficiency have given it a long and useful life and it is these qualities that indicate the future working and durability of this modern rectifier.

A complete range is available for use in AC and AC/DC receivers and battery eliminators, with outputs from 120 volts 20mA, up to 600 volts 120mA. Units of the new range are smaller than earlier models, the overall size of a rectifier to give 600 volts 120mA, for example, is but $4\frac{1}{16}$ " long, with $2\frac{1}{4}$ " square fins.

Write for data sheet No. 49 to Dept. W.W.

WESTINGHOUSE BRAKE & SIGNAL CO., LTD.,

82, York Way, King's Cross, London, N.1

WE CHANGE OUR NAME

PHILIPS LAMPS LIMITED

Today, Philips lamps — tungsten, fluorescent, and discharge lamps and lighting equipment — are known and used all over the world. But the enormous growth of the Company's lamp and lighting interests is not the whole story, and it is because of this that the name of Philips Lamps Ltd. is no longer appropriate to a concern whose activities range over an ever-widening field of electrical development and manufacture. Therefore, we take this opportunity of announcing that, as from 1st September, 1947, the registered name of this Company will be changed to

PHILIPS ELECTRICAL LIMITED

CENTURY HOUSE, SHAFTESBURY AVENUE, LONDON, W.C.2



*It's easy to make Pick-ups
— if you know how.*
The know-how in the manufacture of
Lexington
MOVING COIL PICK-UPS

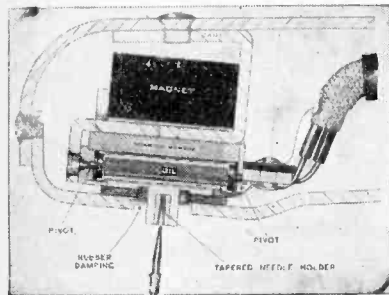

is the result of long experience and precision watch - making standards which give a finely constructed instrument the details of which are shown in the sectional diagram.

DE LUXE MODEL ● Robust design. Accidental dropping on record will not damage Pick-up ● Extremely low moment of inertia (80 milligrams total weight of movement) ● Pure sine wave with no harmonic distortion ● Automatic needle or sapphire changing opens new fidelity field to the amateur ● Can be used with normal record changer without fear of damage. Price (without sapphire) £5.10.0, plus 24/6 P.T.

PLUG-IN HEADS

Available in both junior and De Luxe types to fit Collaro and Garrard arms, thus providing easy change-over from Magnetic types. Input conversion may be required. (See our Technical Brochure.) Price 49/6, plus 11/- P.T. Separate Ejector for De Luxe type, 30/10, plus 6/10 P.T.



Sapphire Needle with specially tapered shank, 15/3 (incl. P.T.)

PRE-AMPLIFIERS having an inverse of the recording characteristic incorporated are available for use with pick-ups. These are necessary with some amplifiers. Price complete with valve and input Transformer, £61.0.

Announcing The **NEW LEXINGTON**

15-WATT HIGH FIDELITY
AMPLIFIER

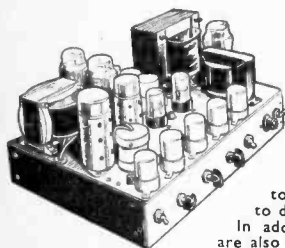

Designed in our laboratories for use with our own Pick-ups, also as an Audio-channel for high quality local station radio feeder units.

The amplifier is available completely constructed or the necessary circuit diagrams and technical details can be supplied to technical amateurs who prefer to do their own construction.

In addition technical details and circuit are also available showing the construction of a high quality **RADIO FEEDER UNIT**

incorporating local stations and television sound bands for use with the above amplifier, making a perfect combination for the connoisseur.

Prices and details of the above will be sent upon request.

This service is introduced at the request of the many satisfied users of our Pick-ups.

Illustrated Technical Brochure upon request.

Export and Trade Enquiries invited.

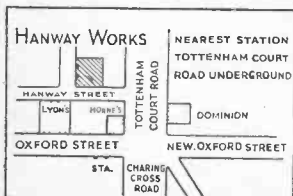

COOPER
MANUFACTURING CO.

HANWAY WORKS,
HANWAYST., LONDON, W.1

Telephone ; MUSEum 9779

SALES OFFICES—Top Floor

SENSITIVE VALVE
Voltmeter

PRINCIPAL FEATURES

VOLTAGE RANGE

1 mV to 100 volts.

FREQUENCY RANGE

50 c/s to 250 kc/s.

ACCURACY

±5% of the actual reading.

INPUT IMPEDANCE

2 megohms.

ZERO SETTING

Stable and remains set on all ranges.

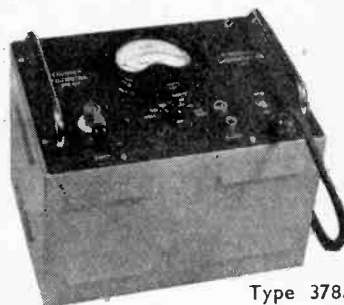

Type 378A

This instrument is now available from stock. Write for full particulars and specification. **PRICE £75**

FHL FURZE HILL LABORATORIES LTD
TELEPHONE BOREHAM WOOD
ELSTREE HERTS
1137

Some remarkably fine offers!

HIGH VOLTAGE TRANSFORMERS. Ex-Government 200-250 v 50 cycle Input 1100-0-1100 v. at 250 mA Output. Weight 25 lbs. Brand new, but most have broken terminal strips due to transport. Otherwise perfectly O.K. and cannot be repeated at this price **50/-**
Post orders. Include 5/- for cost of packing and rail transport.

U.H.F. CONVERTERS. Type 27.60-80 mcs. R.L. Series Valves H.F., Osc. Mixer, 7.5 mcs. I.F. output. Rewind Coils (Osc. coil 6 turns aerial and mixer coils 7 turns) and these Converters cover 5-metre band. Performance is remarkable, and this is one of the best Converters available to-day. Power requirements 6 v. and 200/250 v. **£5**

MCR1 Miniature Communications Rx 5 VALVE SUPERHET. (1R5 Mixer, 1T4 I.F. amp., 1T4 2nd Det. and 1T4 L.F. amp.). Four ranges (4 Plug-in Coil Units). Range 1 : 100 kcs.-1,600 kcs. Range 2 : 2.5 mc/s-5.0 mc/s. Range 3 : 4.5 mc/s-8.0 mc/s. Range 4 : 8.0 mc/s-15.0 mc/s. These Rx are a beautiful job and cost many times our price to produce. As a standby Rx or portable for field days and mobile working they represent one of the finest investments you can make. These are Ex-Government, used but O.K. Less Phones but complete with Power Pack for AC/DC Mains **£8 8 0**

BRAND NEW American Single Button Carbon Breast Assembly. Beautiful job, ribbed aluminium diaphragm. Bakelite case. Complete with 3 position switch. In maker's cartons. These are one of the best Carbon Mikes available to-day, and they are being used by many well-known amateurs **9/6**

MOVING COIL Microphone and Headphone Assembly (Approx. impedance of each unit 48 ohms). Microphone has "Press to Talk" switch; worth £8. Complete **15/6**

Moving Coil Hand Mike with Switch **6/6**

Moving Coil Assembly in bakelite case with 3in. grill. Can be used as midget speaker **4/6**

(ALL the above have genuine Alni magnets.)

YAXLEY TYPE SWITCHES
Double pole 6-way. Ideal meter or multi-band switches, 2/6. Three pole 3-way 2 wafer, 3/6. Single pole 6-way 3 wafer assembly, 3/6. 3 wafer Assembly, 1 wafer 2-pole 4-way ; 2-wafer single pole 4-way, 3/6.
TYPE 1124A RECEIVER. 30.5-40.5 mc/s. Preset Tuned 6 Channel. 6 13V 2a. Valves. 9 9D2's R.F. and 2 I.F. Amps. (7 mc/s 25 kc. band width). 1 15D2 Mixer Osc., 1 8D2 2nd Det., 1 4D1 Triode Output. 3 Westcoaters (WX12 WL and W2) two used for A.V.C. Full wave rect. Very useful for valves and components **35/-**

Post orders plus 10/- for packing and rail transport.

RADIOMART 48 HOLLOWAY HEAD, BIRMINGHAM, 1

Fidelity

True TO LIFE - Faithful TO TRADITION

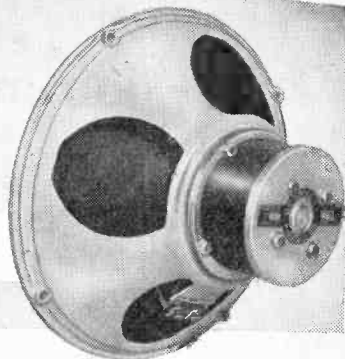

GOODMANS

LOUDSPEAKERS

Goodmans 12" medium heavy-duty reproducer. Ideal for small cinemas, P.A. systems and high power radiograms. Available in Chassis or Cabinet form.

★ A TRADITION OF EXCELLENCE



GOODMANS INDUSTRIES LTD.
LANCELOT ROAD, WEMBLEY, MIDDX.

Something like a range!

**45 MAINS TRANSFORMERS
42 SMOOTHING CHOKES
8 OUTPUT TRANSFORMERS**

for immediate delivery



Every normal need is covered by this comprehensive range of Transformers and Chokes. Full details, specifications, prices, etc., are given in three leaflets, copies of which should be on your files.

COUPON Please send me complete lists of the Somerford range of TRANSFORMERS AND CHOKES.

NAME

ADDRESS

FOR RADIO • INDUSTRY • LABORATORY

GARDNERS

**'SOMERFORD' TRANSFORMERS
AND SMOOTHING CHOKES**

GARDNERS RADIO LIMITED,
SOMERFORD, CHRISTCHURCH, HANTS.

There's a size
for every job in
the S.P. range
of metallised
bushes



**METALLISED
BUSHES**

Please write for Catalogue No. 25.

STEATITE & PORCELAIN PRODUCTS LTD.

STOURPORT ON SEVERN, WORCS. Telephone: Stourport III. Telegrams: Steatite, Stourport.



S.P.50

Wireless World

Radio and Electronics

Proprietors:
ILIFFE & SONS LTD.

Managing Editor:
HUGH S. POCOCK,
M.I.E.E.

Editor:
H. F. SMITH

Editorial, Advertising
and Publishing Offices:
DORSET HOUSE,
STAMFORD STREET,
LONDON, S.E.1.

Telephone:
Waterloo 3333 (50 lines).

Telegrams:
"Ethaworld, Sedist, London."



**PUBLISHED
MONTHLY**

Price: 1/6

(Publication date 26th
of preceding month)

Subscription Rate:
Home and Abroad
20/- per annum.

37th YEAR OF PUBLICATION

SEPTEMBER 1947

MONTHLY COMMENTARY	313
IS A BIG AERIAL WORTH WHILE? By M. G. Scroggie	314
BASS COMPENSATION By J. Ellis	319
R-C OSCILLATOR CONTROL By B. J. Solley	321
TEST REPORT: BUSH TELEVISION MODEL T91	323
BROADCAST RECEPTION FOR SCHOOLS	327
SHORT-WAVE CONDITIONS By T. W. Bennington	329
TELEVISION RECEIVER CONSTRUCTION—7	330
WORLD OF WIRELESS	335
MAGNETIC UNITS By "Cathode Ray"	339
LETTERS TO THE EDITOR	343
BOOK REVIEWS	345
UNBIASED. By "Free Grid"	347
RANDOM RADIATIONS By "Diallist"	348
RECENT INVENTIONS	350

Branch Offices:

COVENTRY:
8-10, Corporation Street.
Telephone: Coventry 5210.

Telegrams:
"Autocar, Coventry."

BIRMINGHAM:
King Edward House,
New Street, 2.

Telephone:
Midland 7191 (7 lines).

Telegrams:
"Autopress, Birmingham."

MANCHESTER:
260, Deansgate, 3.

Telephone:
Blackfriars 4412 (4 lines).

Telegrams:
"Iliffe, Manchester."

GLASGOW:
26B, Renfield Street, C.2.

Telephone: Central 4857.
Telegrams: "Iliffe, Glasgow."



As many of the circuits and apparatus described in these pages are covered by patents, readers are advised, before making use of them, to satisfy themselves that they would not be infringing patents.

**"P" COILS
AVAILABLE NOW...**

... in all ranges from 12-2000 metres, including Aerial, H.F. Transformers and Oscillators.

Don't be put off with excuses if your dealer cannot supply the famous "Wearite" series of "P" Coils and I.F. Transformers from stock. There's no reason why you can't have them on demand—they're available NOW! If any difficulty, write to us giving your dealer's name and address.

Wright & Weaire Ltd., 2 Lord North Street, London, S.W.1.
Telephone: ABBey 2126. Factory: South Shields, Co. Durham.



VALVES AND THEIR APPLICATIONS

By M. G. SCROGGIE, B.Sc., M.I.E.E.

No. 9: Mullard DOUBLE-DIODE-TRIODE EBC33

THE use of a double-diode-triode as a combined detector, a.g.c. rectifier, and a.f. amplifier has been common practice for so long that comment on this application may be superfluous. There are of course many examples of highly specialized circuitry using diodes and triodes which can conveniently be combined. Radar personnel will no doubt be able to think of some. Between these two extremes is a field of common though not mass-production application—oscillators, in many of which there are advantages to be gained by employing a diode for automatic amplitude control (a.a.c.).

One generally wants to be sure that an oscillator will oscillate, even though everything chance to be lower-limit; so the tendency is to aim for plenty of margin. What happens then is that oscillation is obliged to build up to a more or less excessive amplitude in order to introduce sufficient losses or reduction of valve gain to arrive at a balance of power. This condition is not conducive to good waveform and frequency stability. A grid condenser and leak, by developing a negative grid bias nearly equal to the peak value of oscillatory voltage at the grid, provides automatic restraint both of amplitude and of anode current (which otherwise is liable to become uneconomical or even injurious to the valve), but does not altogether overcome the other disadvantages, and unless one is careful is liable to squegg.

The principle of a.a.c. is to separate the biasing and grid-driving functions, using a diode to provide the control bias and thus making it possible for the amplitude of oscillation to be (if desired) much less.

The diagram shows a very simple adaptation of the Hartley circuit to a.a.c. Besides simplicity and effectiveness, this circuit is very uncritical as regards component values. Those specified are suitable for frequencies of the order of 10^5 – 10^7 c/s; but the circuit can be used for a.f. If C_1 and C_2 are unnecessarily large they render the

a.a.c. sluggish and transient fluctuations consequently prolonged. The normal position for the coil tapping is that which divides the coil in the ratio 1:A, where A is the amplification of the valve under desired operating conditions. Unless oscillation is only barely possible, the exact point is not at all critical.

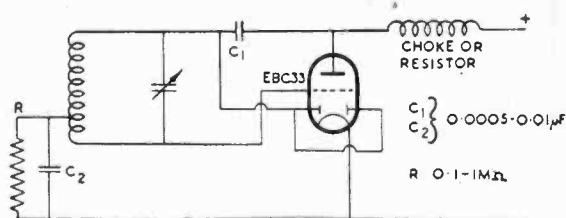

This circuit does not keep the amplitude closely constant under all conditions—it is roughly proportional to H.T. voltage, for example, and varies somewhat with Q or load—but it does keep it well within the grid base and maintains I_a always at a minimum for the load applied.



This is the ninth of a series written by M. G. Scroggie, B.Sc., M.I.E.E., the well-known Consulting Radio Engineer. Reprints for schools and technical colleges may be obtained free of charge from the address below. Technical Data Sheets on the EBC33 and other valves are also available.

**THE MULLARD WIRELESS SERVICE CO. LTD.,
 TECHNICAL PUBLICATIONS DEPARTMENT,
 CENTURY HOUSE, SHAFESBURY AVE., W.C.2**

Wireless World

Radio and Electronics

Vol. LIII. No. 9

SEPTEMBER, 1947

Price 1s. 6d.

MONTHLY COMMENTARY

Reading "Wireless World"

LIKE every other periodical, *Wireless World* observes certain journalistic conventions—not from any slavish adherence to tradition, but because it is thought that to do so makes reading easier. That object would be attained if every reader could be assumed to know the rules; recent experiences make us doubt if such an assumption is justified, and so a brief exposition of these conventions, as observed by this journal, should be helpful.

The obligation on every responsible publication to draw a clear distinction between news and views is already widely known. We are constantly on our guard, when reporting happenings in the world of wireless, to avoid the slightest coloration of the facts in order to bring them into harmony with the interests of this journal or the personal views of the individual concerned. Equally, we take care that the distinction between fact and comment is made clear at the most superficial reading. Where any useful purpose is served by doing so, we give the source of the information. The spreading of rumours has no place in a responsible technical journal, but occasionally it is thought desirable to print a report that cannot be verified. Here it is our practice to warn the reader by prefixing the paragraph with some such phrase as "According to a report from . . ."

The difference between a signed and an unsigned article is not always fully appreciated. The unsigned contribution may always be assumed to be one for which we assume the fullest responsibility, both for statements of fact and expressions of opinion. Such material is almost always written by a member of the staff; on the rare occasions where it is not, by someone in whom we repose equal confidence. Articles signed by the name or initials of the author or by a *nom de plume* are in an entirely different category. Here *Wireless World* takes the usual precautions to verify facts, but any views expressed are those of the author; we do not necessarily agree with them. This is

not a case of shelving responsibility; the onus of deciding whether the author's views are worth expressing rests, of course, on us, as does the legal responsibility for libellous statements or infringements of the Official Secrets Act, etc.

As we limit our endorsement of signed articles, still more do we decline to endorse the views expressed by writers of "Letters to the Editor." Sometimes, indeed, we print communications with which we disagree most profoundly, in the hope that they will provoke discussion. Radio has recently celebrated its jubilee as an applied science, but it is still a growing art, and there is often need to clarify ideas and even to dispel widely held misconceptions. The present correspondence on "Loudspeaker Damping" will probably turn out to be a case in point. Anonymous letters are never published, though *noms de plume* are accepted if authenticated by the writer's name; especially if we are convinced that the writer has reasonable grounds for concealing his identity.

In touching upon this question of anonymity we are raising one of the skeletons of the journalistic cupboard. All our inclinations are towards the contribution signed with the writer's name, whether in the form of a letter or article, but particularly the latter. The catch-phrase "Freedom of the Press" involves at least three freedoms, of which we are modest enough to think that our own freedom to print is the least. The reader's freedom to read the latest information on his chosen subject is far more important, but this he cannot enjoy unless the writer is equally free to write. There is a regrettable and increasing tendency in some less-enlightened quarters to place obstacles in the way of the technical writer, and so it is not surprising that he sometimes wishes to shelter under a pseudonym. This discouragement of authorship is especially to be deplored in relation to technical journalism, which depends on the technician rather than the professional writer for outside contributions.

Is a Big Aerial

Clarifying Ideas on an Awkward Problem

FROM time to time it is urged that much of the performance of a broadcast receiver is thrown away if it is not connected to a good aerial.¹ Nevertheless, the general public show no signs of profiting by this advice. Quite the contrary, so far as one can see there is no break in the increasing tendency to rely on stray pick-up from the mains, the line cord, or at most a piece of wire around the room.

Who is right—the experts or the public?

The public would probably argue that they are not very much interested in performance; not enough, at any rate, to go to the bother and expense of erecting an electromagnetically

back to the locals. Many of these people probably fail to realize how much better off they would be if they installed a proper aerial.

It is only natural for the dealer, when his customer quotes his rival's claims, to assert that his sets, too, need no aerial. Would not the customer suspect him of ulterior motives if he urged the extreme desirability of having an elaborate aerial installation put in hand, of course at extra cost? And the manufacturer is caught up in the same web of circumstance, for if he designed his receivers primarily for use

performance. Such consideration may profitably be given by owners or designers of more or less ordinary broadcast receivers who want to get the best out of them, and still more by enthusiasts whose interests lie with sets of the communications type.

Leaving out of account sets with no provision for external connection, the aerial is the one item in the complete outfit which is outside the control or knowledge of the commercial designer. He is therefore faced with a number of indeterminate variables. Not only is the range of probable signal input voltage greatly extended by this uncertainty, but—a still more tricky problem—he has to guarantee the preselector tuning without knowing what sort of impedance may be connected (or left unconnected) to Aerial and Earth.

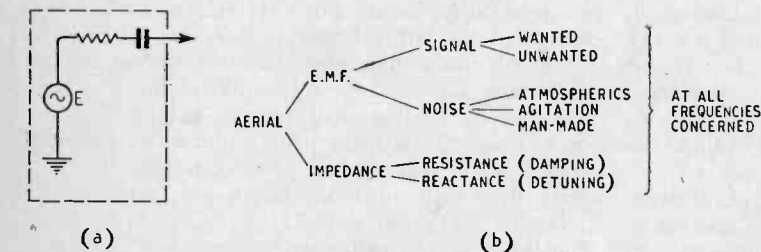

Fig. 1. The equivalent circuit of an aerial (a), and its properties and products analyzed (b)

good outdoor aerial, which is liable to be carried away by gales or struck by lightning, spoils the appearance of the place, anchors the receiver to one position in one room, and may even be prohibited by the landlord. Moreover, did not the dealer say an aerial was unnecessary and actually impaired the selectivity? So long as the main programmes can be heard satisfactorily without all this trouble, why worry?

So long as one can, and so long as one is content with no more, why indeed?

No doubt the great majority of listeners can be dismissed at this point. But there surely remain a substantial number who, because of strong local interference, cannot satisfy even these modest desires, and others who would like to hear a wider choice of programmes but who find them so crackly that it is a relief to turn

with an outdoor aerial, they would compare badly with other makes on the far more likely "bit of wire." So it is hardly surprising if a general impression exists that a set for which an outdoor aerial is recommended must be a pretty poor sort of affair.

Wireless World readers, whose motives no doubt are beyond suspicion, can help the uninstructed and suffering public to achieve quieter and/or more varied reception by overcoming this prejudice, explaining in simple terms the function of the aerial and suggesting how it might be arranged to meet the listener's objections while being reasonably efficient. There is, of course, always the risk of being called upon actually to do the job, but, well . . .

Maximum Performance

Before embarking on a propaganda campaign, it would perhaps be as well to clarify our own ideas, and to consider the aerial question on a basis of maximum per-

The aerial can be regarded as a generator of assorted R.F. E.M.F.s, good and bad, with its internal impedance, as shown in Fig. 1a. At any one frequency the impedance can be specified simply as a resistance and either a capacitance or inductance, but these elements vary widely over the usual wavebands.

Fig. 1b is an analysis of the subject that may help to guide our thoughts. First, considering the aerial in its intentional role as a source of desired signals, such signals cover a wide range of voltage, which may be represented as in Fig. 2 (a—g). The top limit is the E.M.F. generated in the aerial by the strongest field produced at the place of reception by a station that is liable to be wanted; the "local station," say. The bottom limit is the weakest wanted E.M.F. that is capable of overriding noise E.M.F.s to the satisfaction of the listener furnished with a perfect receiver. In a quiet situation (i.e., one rela-

¹ For example, by the Editor on page 235 of the July issue, and by a correspondent, T. H. Kinman, on page 192 of the May issue.

Worth While?

tively free from atmospheric and noise picked up by the aerial) the latter limit is low, giving a large range of available signal strengths, as at *a*. In a noisy situation, on the other hand, it is high, as at *b*.

By M. G. SCROGGIE, B.Sc., M.I.E.E.

Putting up a larger aerial in the *b* situation raises the diagram bodily, as at *c*, if it is assumed that signal and noise continue to be picked up in the same ratio. As is well known, however, if the source of noise is close to the receiver the likelihood is that the large aerial will pick up little more of it than the smaller one, so the diagram will look more like *d*. This compares more nearly with *a* for range of signals available, and in addition is at a higher general level. At the opposite extreme, *e* represents a very small aerial in a noisy situation, and *f* the same aerial in a quiet situation. Lastly *g*, a large aerial with low noise. (A "large" aerial herein means one that develops a relatively strong E.M.F. from a given field, whether mainly because of size, shape, or position.)

On the right-hand side are shown to the same scale the corresponding limits of the receiver; at the top the strongest signal that can be applied to the aerial terminal without overloading the set, and at the bottom the weakest signal that can override the internally generated "set noise." The extent of the receiver acceptance range depends on what the listener is prepared to tolerate as regards overloading and noise. But taking that for granted it can be increased by good design, as illustrated at *j* compared with *h*. The general level of the range is determined by the aerial coupling; with a looser coupling (*k*)

the receiver obviously requires (or can stand) a stronger input from the aerial.

These diagrams must not be taken too literally, of course, because they are subject to such complications as aerial impedance, the effect of the aerial connection on set noise, and—most of all—the nature of the overloading (whether it is due to the wanted signal or to some other). These details will be considered in turn, but in the meantime it should be noted that whereas there is no limit to shifting the acceptance range upwards by loosening the coupling (except for pick-up by the receiver other than *via* the aerial socket) there is a very definite point beyond which the lower limit cannot be shifted down by tightening it.

So, comparing the two sides of Fig. 2, it appears that to get the maximum choice of signals the aerial ought to be at least large

be quite loose. That being so, the real risk is that by using too small an aerial a large part of the range of signals brought in by it may be below the lower limit of the receiver and thereby lost, while at the same time a large part of the receiver's range may be above the aerial's top limit and so never used. Tightening the coupling to adapt a receiver to a weak-signal aerial had bad secondary effects, such as detuning; but loosening it for a strong-signal aerial has good secondary effects, and moreover is the more easily done without getting inside the receiver.

Flexible Input Circuits

Regarding the aerial as a source of signals, then, it seems fair to say "the bigger the better." At the same time it ought to be noted that the benefit of a really good aerial in a quiet locality with a strong local station cannot be fully realized unless the whole of its extensive range of signal level comes within the receiver limits. In other words, the receiver should be well designed and expensive enough for its limits to be far apart, or should be provided

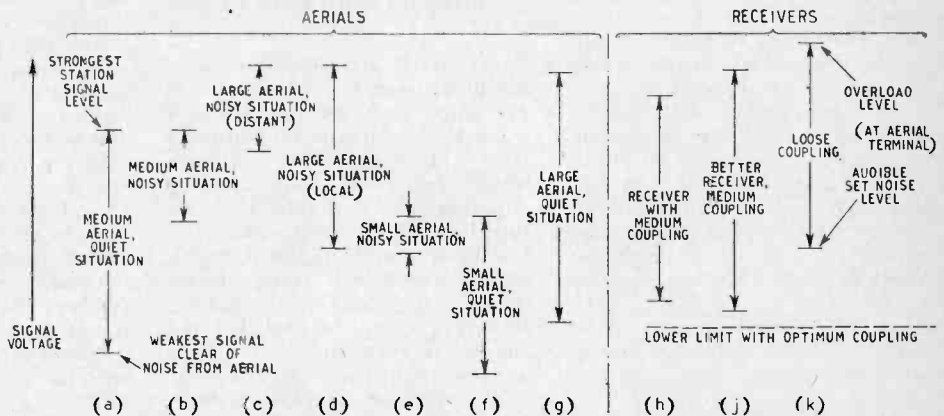

Fig. 2. Diagrams representing the upper and lower useful signal limits of different aerials and receivers. Ideally the depth of the aerial line (for a given "strongest station") should be as great as possible, and the receiver line should embrace at least the same range.

enough for its bottom limit to be above the dotted line. It might then appear that there is a risk of its top limit coming above the receiver top limit. In practice this is unlikely to happen, because as we shall see later it is generally necessary or desirable for other reasons that the coupling should

with variable or alternative coupling.

Unfortunately many receivers, and not least the latest, are neither. Of the twenty-eight 1946-7 models for which information was available, and capable of being connected to an aerial, not one has a preselector stage, and

Is a Big Aerial Worth While?—

all but three have fixed aerial coupling, without even a choice of socket to suit a large or small aerial (unless the provision of an internal frame or plate aerial in five others can be reckoned as an alternative "coupling"). As we have seen, the designer of a fixed-coupling set is almost bound to assume the aerial will be small. Connecting a very large aerial, which if appropriately coupled would give much better reception, may therefore be liable to produce some of the following results:—

(1) Cross-modulation, due to a strong unwanted signal being of such an amplitude as to sweep one or more valves over a sufficiently non-linear range for its own modulation to be impressed on the wanted carrier wave, no selectivity beyond this point being of any avail to remove it. The general abandonment, in these austere days, of more than one tuning circuit before the frequency-changer, accentuates this trouble. (Only one of the twenty-five fixed-coupling sets mentioned has hand-pass tuning.)

(2) Whistles, due mainly to excessive strength of unwanted signals.

(3) Distortion, due to overloading of pre-volume-control stages by a wanted local signal.

(4) Interference to other listeners by oscillator radiation. For example, a listener to Droitwich on 200 kc/s, using an I.F. of 465-470 kc/s, has his oscillator working at a frequency that could seriously worry his neighbour tuned to North Regional on 668 kc/s.

(5) Other disadvantages to be considered under the heading of aerial impedance.

Better Sets Wanted

The moral of all this is not that aeriels capable of long-range reception should forthwith be universally abandoned, but that wherever possible the receiver should include a preselector stage or at least a two-circuit tuner, and of course well-designed valve operation; and that sets which unhappily must conform to the present economy régime should as an absolute minimum have two alternative aerial sockets, and not

attempt the impossible, as so many do.

So far we have considered a larger aerial primarily as delivering a stronger signal. But it is not necessarily used in this way, which, as we have seen, may be undesirable unless the receiver has adequate preselection or other provision against overloading. The alternative advantages of a large aerial are related to the other items in the left-hand column of Fig. 1b.

Undesired signals, for example. It has often been stated that a

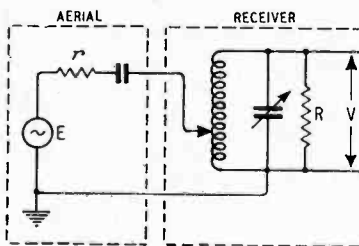

Fig. 3. R is the value of the dynamic resistance of the tuned circuit (with aerial disconnected) together with the valve input resistance and any other losses, for purposes of calculating maximum signal voltage V .

larger aerial reduces selectivity. Assuming connection is made to the same coupling that suits a smaller one, that is undoubtedly true. It does it in two main ways: by overloading, and by damping and detuning the first tuned circuit. Overloading has just been discussed, and damping and detuning will come up for consideration later. Anticipating, however, it may be said that the answer is just the same—it is not the size of the aerial that is at fault; suitably coupled, a large aerial is in general better for selectivity than a small one.

Next there is noise. While atmospherics (worst at the lower frequencies) and celestial noise (worst at the very high frequencies) certainly increase as the aerial is enlarged, the signal/noise ratio is hardly likely to be worse, and may well be better, because even if the aerial is omnidirectional a low one is generally more screened from the signal source than from natural noise.

And, of course, if it is practicable to make the aerial directional there is considerable scope for discriminating against noises of these kinds.

But it is with regard to man-made noise that the possibilities of the aerial are greatest. It must be a familiar story to nearly all readers; that an indoor aerial is closely coupled to all the electrical noise generated in the house and brought into it by wires, etc., while it is more or less screened from radio signals so that even the strongest may not always override the noise. An outdoor aerial, even without any special anti-interference features, normally brings in far more signal than additional noise, so the ratio goes up strongly in favour of the listener. But obviously this simple truth has yet to penetrate many of the homes of the people.

In the more difficult situations—those in which severe interference comes largely from outside the house—merely putting up an outdoor aerial may not be enough; a specially sited aerial with a screened lead-in may be needed.

So much for the aerial as a signal source. Turning now to its impedance; it is impossible to connect an aerial to a receiver in such a way as to use the aerial as a signal collector without transferring some of its impedance to the receiver. The effect of the resistive component is to reduce the Q and hence the selectivity of the circuit to which it is coupled, and the effect of the reactive component (inductive or capacitive) is detuning, which, if not corrected, further reduces selectivity, and signal strength as well. So the problem is to couple the aerial in such a way as to introduce as much as possible of at least the weakest wanted signals, reduce selectivity as little as possible, detune as little as possible, and do all of these things over all the wavebands of the receiver, preferably without any effort on the part of the listener.

The object of the present inquiry is not to solve this admittedly sticky problem but to decide how the size of aerial affects the matter in terms of results.

Referring to Fig. 3, the aerial is shown as a generator of (among

other things) a desired voltage which we denote by E , a resistance r , and a reactance, usually capacitive. This system is coupled in any of a large variety of different ways to the input tuned circuit of the receiver, across which it is desired to set up a signal voltage; call it V . With the aerial disconnected, the resonant tuning circuit can be represented as a resistance—the dynamic resistance—denoted in Fig. 3 by R . The input resistance of the valve, which at the very high frequencies may be low enough to dominate the situation, can also be incorporated in the value of R .

Assuming first of all that the set noise is negligible compared with V , and that the object is to make V/E as great as possible, the well known law of generator and load supplies the answer; namely, that the aerial coupling must be arranged so as to make the receiver, looked at from the aerial, have a reactance equal and opposite to the aerial's (so neutralizing it) and an equal resistance. This done, the voltage across r is obviously $E/2$ and the power dissipated in it is $E^2/4r$. The power delivered to the receiver is clearly V^2/R , and as the matched load condition just applied makes these quantities equal we have

$$E^2/4r = V^2/R$$

and hence

$$V = \frac{E}{2} \sqrt{\frac{R}{r}}$$

as the condition for maximum possible V , assuming no loss introduced by the coupling. Given this perfect coupling, the aerial yielding the strongest signal is the one with the highest E/\sqrt{r} . Putting up a large well-designed aerial greatly increases E and may even reduce r in comparison with that of an inefficient indoor aerial. Certainly it would have to be very bad for r to increase as rapidly as E^2 !

The ideally coupled aerial appears to the receiver as the equivalent of a resistance equal to R in parallel with its own R , so the effect on the Q of the receiver circuit is to reduce it by one half. And since at any given frequency Q is a measure of the selectivity, that also is reduced

by a half. While it is true that nearly all receivers nowadays are superhets, in which the first tuned circuit has very little influence on adjacent-channel interference, yet its selectivity is important for protecting the receiver against cross-modulation, second-channel interference, I.F. interference, and certain whistles. Whereas a poor aerial, with small E and large r , has to be fairly closely coupled in order to deliver a reasonable V , a large aerial can give equal or greater V with far less than optimum coupling, and the natural selectivity of the pre-selector need therefore hardly be affected.

Selectivity and Signal Strength

So in a true sense the large aerial promotes selectivity as well as signal strength. But again the important thing is coupling. Fig. 4 shows how coupling can be reduced considerably below optimum before signal strength falls off badly, while selectivity is substantially improved. A large aerial allows one to reduce the

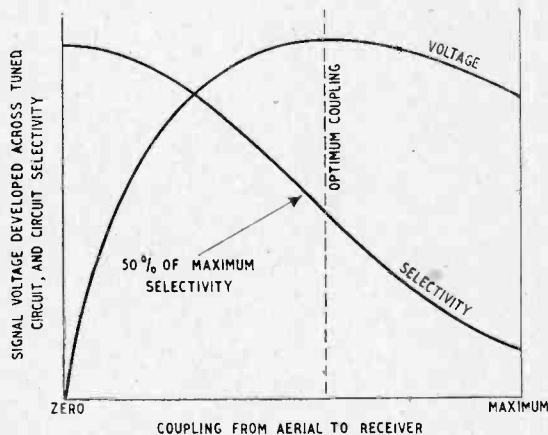

Fig. 4. Typical effect on signal voltage across the pre-selector tuning circuit, and on its selectivity, of varying the aerial coupling.

coupling much more than a small one.

These curves also indicate the deplorable effects of connecting a large aerial via a coupling that is optimum for a small one—both selectivity and signal strength are less than they could be.

When set noise is the limiting factor, as it is when receiving weak signals of very high frequency on an adequately sensitive receiver, signal/noise ratio rather than signal strength is the criterion. This subject has been

dealt with recently by L. A. Moxon² so there is no need to do more than recall that the coupling giving maximum signal-noise is *closer* than the matched-load optimum which delivers the strongest signal, especially if the set noise is mainly thermal agitation in the input circuit. This happens because the loss of signal caused by overcoupling is not as rapid as the reduction in thermal noise resulting from the shunting effect. If the valve shot noise predominates, however, there is negligible advantage in overcoupling.

Lastly, aerial reactance. Although it is possible at any one frequency to neutralize it by, say, an equal and opposite reactance in series, this not only introduces more resistance but is hardly practicable over wide tuning bands. So in practice the aerial reactance either detunes the first circuit, or has had to be corrected. Detuning is of course even worse than damping, in that it may actually strengthen interference as well as weaken the wanted signal. Cor-

rection would be easy if the aerial plus its coupling were equivalent to a constant capacitance or inductance throughout any tuning band, because it could be done

once for all in the design, and the ganging would not be upset. It is difficult enough to achieve such a coupling even if the properties of the aerial are known in advance, and impossible if they are not. Moreover, the type of coupling that comes nearest to this ideal is quite unlikely to be the best for signal transfer and selectivity also over the whole tuning range. So the designer has to arrive at some compromise that gives as fair a balance as pos-

² *Wireless World*, May, 1947, pp. 171-176.

Is a Big Aerial Worth While?

sible of all three interests at all working frequencies and with all possible aeriels. Of course it is an outrageous demand. Nearly every designer tries something different, but is any satisfied?

It is a different matter altogether with a fixed-frequency installation, or even for the enthusiast who does not mind adding variable coupling and variable aerial tuning controls to his DX receiver. But in a saleable broadcast set it is necessary to fix the coupling much below optimum in order to avoid excessive detuning. Some types of coupling can be

But if a large aerial is connected by a coupling designed for a small one, the results are excessive detuning, damping, and overloading; while the reverse gives very poor signal strength in relation to set noise (see Fig. 2 again). So here once more the importance of suiting the coupling to the aerial stands out.

Summarizing, then: even with a coupling designed for it, an indoor aerial or mains aerial deprives one of weak-field programmes, either because the signal voltage delivered by it is insufficient to give a useful output if the gain of the receiver is

limited, or to override set noise if gain is unlimited. Such an aerial may even fail to supply noise-free reception of any programme, owing to its vulnerability to local interference. A good outdoor aerial, on the other hand, is better in every respect — signal strength, signal/noise ratio, selectivity, and absence of detuning. Either sort of aerial unsuitably coupled gives very poor results, but it is easier to remedy the faults externally with the large aerial. It is up to the set-maker, however, to render his 4+1 products suitable

both for the Home-and-Light brigade and for those who want better results. A great all-round improvement in broadcast reception would result at trifling cost if he would at least fit two alternative aerial sockets. The small-aerial or "no"-aerial people could then get a rather stronger signal, while there would be no need to deter the more ambitious listeners from putting up a large aerial. Where economy is not so binding, a more flexible coupling still, and better preselect-

tion, are the clues to an improved range of signal acceptance.

MANUFACTURERS' LITERATURE

VITRIFIED enamel and fired metal markings on glass are described in a new publication (2572) "Permanent Scales and Markings on Glass," issued by Johnson, Matthey and Co., 73-83, Hatton Garden, London, E.C.1.

List No. 132, Issue No. 1, "Capacitors—Paper, Mica, Ceramic," from The Telegraph Condenser Co., North Acton, London, W.3.

Receivers for export (Models E.A.C.91, E.U.91, E.A.C.95 and E.U.95) are described in a coloured brochure issued by Bush Radio, Power Road, Chiswick, London, W.4.

The following illustrated leaflets have been received from Rediffusion, Broomhill Road, London, S.W.18: "Industrial Radio Heating, an "Introduction," "Radio Heat Plastic Welder, Model J.P.1," "Communication Equipment, Radio and Audio Frequency Installation for Ground, Sea and Air Services."

New edition (including text in French and Spanish) of "For Those Who Seek the Finest Cored Solder in the World," an illustrated brochure giving technical details of Ersin Multicore solder, from Multicore Solders, Mellier House, Albemarle Street, London, W.1.

Illustrated leaflet describing V.S.E. receivers and sound amplifying equipment from V.S.E. Construction Co., 5-7, Denman Street, London, W.1.

Leaflet describing permanent-magnet loudspeakers made by Richard Allan Radio, Caledonia Road, Batley, Yorks.

Catalogue of electrical products (issue No. 4) from M.O.S., 24, New Road, London, E.1.

"Push-pull Phase Splitter": Correction

In expression (3) of the appendix (our August issue) the square should have been omitted from μ_1 in the numerator. This article by Capt. E. Jeffery, A.M.I.E.E., was written by permission of the Commandant, Electrical Wing, R.E.M.E. Training Centre.

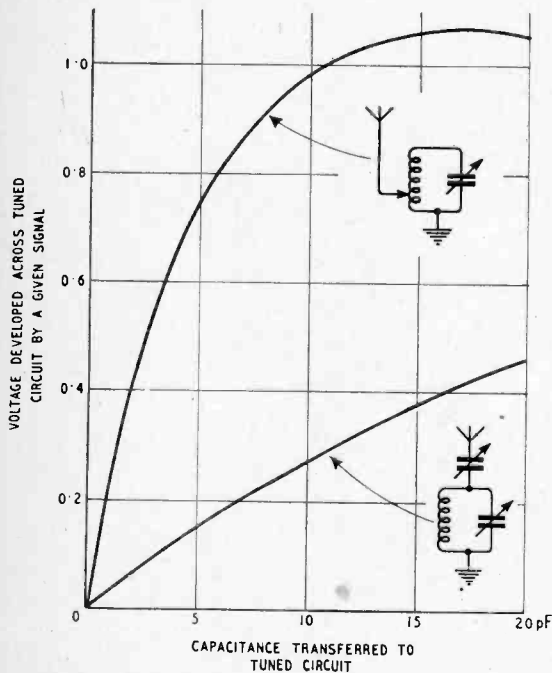
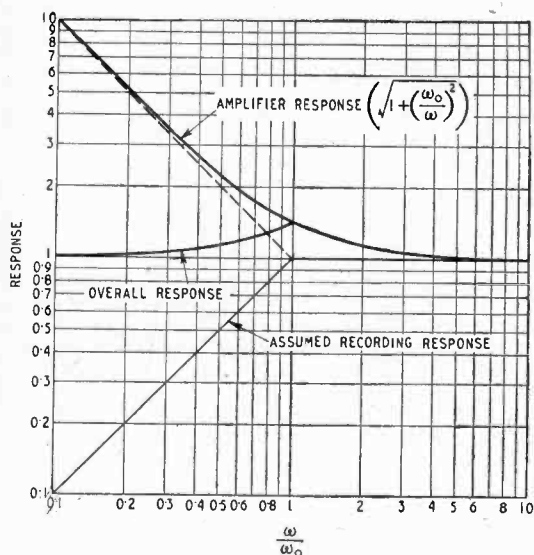

Fig. 5. Typical measured results showing how inductive coupling gives much stronger reception for a given small transfer of aerial capacitance to the tuned circuit than series capacitance coupling.

closer for a given detuning than others; Fig. 5, for example, compares auto-transformer and series capacitor methods, showing the great superiority of the former. The whole business would be very much easier if one could assume that all aeriels were of one kind, either large or small. But of the two, large would be far the better, because for a given signal delivery it can be coupled so much more loosely. Or, alternatively, for a given detuning it delivers so much stronger a signal.

Bass Compensation



proportional to the amount of feedback (β); so that if this is made proportional to frequency, the output may be

expressed as $\frac{\omega_0}{\omega}$

where ω is the angular frequency and ω_0 is the angular frequency at which the gain is unity.

If this response is added to the

Fig. 1. Calculated response when feedback is 90 degrees out of phase.

IN a disc recording the output from the pickup is proportional to the transverse velocity of the needle in the groove. Hence, with constant output the recording amplitude is inversely proportional to the frequency, and the required amplitude for very low notes becomes impracticably large. This is normally overcome by having a recording response which is constant above a given frequency (usually about 250 c/s), and proportional to frequency below this.

In order to restore the response, the gain of the reproducing amplifier must be constant above 250 c/s and inversely proportional to frequency below this.

The usual circuits amplify above the normal level required and produce a response of approximately the right shape by a series of R-C filters. These can be made very close to the theoretical response with a carefully designed circuit, but have the disadvantage that they tend to be critical in the choice of component values and it is difficult to vary the frequency at which correction starts.

The following system is based on the fact that in an amplifier of high gain with negative feedback the response is inversely

original signal the response is $\frac{\omega_0}{\omega} + 1$, which is correct at low

and high frequencies, but when $\omega = \omega_0$ the gain is 2 instead of 1. If however the two components are 90° out of phase the magnitude

is $\sqrt{1 + \left(\frac{\omega_0}{\omega}\right)^2}$ which is $\sqrt{2}$ when $\omega = \omega_0$. This is only 3db up on what is required, giving an overall response of $\pm 1\frac{1}{2}$ db.

Fig. 1 shows the response from a device of this form

It is expressed in terms of $\frac{\omega}{\omega_0}$.

A simple circuit having this response is shown in Fig. (2).

If the input is v_i and the output is v_o and the gain of the amplifier is high the voltage at the grid of the valve can be taken as zero, so

$$v_i \frac{R_2 + \frac{1}{j\omega C}}{R_1 + R_2 + \frac{1}{j\omega C}} + v_o \frac{R_1}{R_1 + R_2 + \frac{1}{j\omega C}} = 0$$

$$\therefore \text{Response} = \frac{v_o}{v_i} = - \frac{R_2 + \frac{1}{j\omega C}}{R_1} = - \frac{R_2}{R_1} \left(1 + \frac{1}{j\omega CR_2} \right)$$

A System Using Negative Feedback

By J. ELLIS, B.Sc.

Thus the normal gain is $\frac{R_2}{R_1}$, and

$$\omega_0 = \frac{1}{CR_2}$$

By making $R_2 > R_1$ this circuit can provide gain as well as bass compensation, but of course this reduces the available increase for low frequencies since the upper limit of gain is the normal gain of the valve without feedback.

With an R.F. pentode and a fairly high H.T. voltage, a gain of 200 can be obtained. In pushing up the gain, however, R should be kept small in comparison with

Fig. 2. Practical circuit giving response shown in Fig. 1.

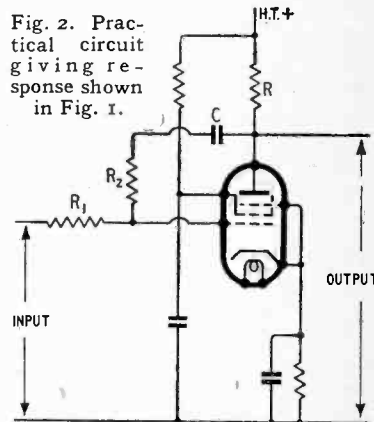

R_2 to avoid a shunting effect by R_2 since R and R_2 are effectively in parallel as the grid is nearly at earth potential.

The best theoretical way of varying ω_0 is by making C variable, but it is often more convenient in practice to vary R_2 .

This alters the gain unless a double-ganged potential divider is used and R_1 made proportional to R_2 . This complicates matters by altering the impedance of the feedback circuit and seriously

Bass Compensation—

limits the upper value of R_1 and R_2 , due to the difficulty of obtaining high-value "pots."

If then a fixed value of ω_0 or only a small adjustment is required this circuit provides an accurate bass compensation with a simple circuit and 20 per cent tolerance components. Of course, more accurate values are required to give a precise value of ω_0 , but as ω_0 can be varied easily this is of little importance. Moreover, this circuit is practically distortionless because of the large proportion of negative feed-back, for although the feedback may not be very great at low frequencies in some cases the feedback at the harmonic frequencies will be much more effective and it is the harmonics in the output which cause the trouble.

If a wide variation of ω_0 is required, the rather more complex circuit of Fig. 3 is better. This, roughly, produces a response of

$j \frac{\omega_0}{\omega}$ and this is added to the original. ω_0 can be varied by

Fig. 3. Recommended circuit for wider range of values of ω_0 .

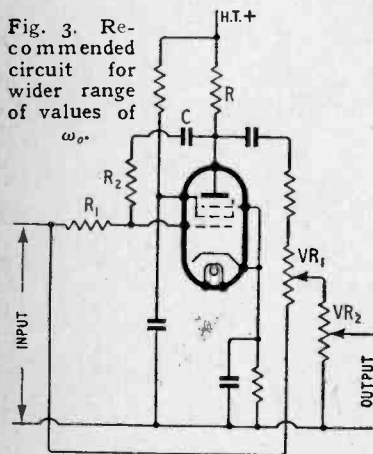

altering the proportion added to the original signal. Call this proportion α , then the response is:

$$\begin{aligned} I - \alpha \frac{R_2}{R_1} \left(I - \frac{1}{\omega CR_2} \right) \\ = I - \alpha \left(I - \frac{I}{\omega CR_2} \right), \text{ if } R_1 = R_2 \\ = (I - \alpha) \left(I + \frac{\alpha}{j\omega CR_2(I - \alpha)} \right) \\ = (I - \alpha) \left(I + j \frac{\omega_0}{\omega} \right), \end{aligned}$$

$$\text{where } \omega_0 = \frac{\alpha}{CR_2(I - \alpha)}$$

α is varied by VR_1 . By varying α between 0 and 1, ω_0 can be varied between 0 and ∞ .

I have not given exact circuit values for these two circuits as they will vary with the type of valve used, the H.T. supply available, the gain required and the amount of variation of ω_0 required.

Using the circuit of Fig. 2 and requiring unity gain and a frequency of 250 c/s for the start of the correction, with an H.T. supply of 250 volts, and using an EF36 $R_1 = R_2 = 1M\Omega$, $R = 220 k\Omega$, $C = 600 \mu\mu F$ and a screen-dropping resistance of $2.2M\Omega$ should give good results. A pot included as part of R_2 will provide fine adjustment for ω_0 .

In the circuit of Fig. 3 $R_1 = R_2 = 1M\Omega$, $R = 220k\Omega$, $C = 200 \mu\mu F$ will give $\omega_0/2\pi = 250c/s$ when $\alpha = 0.25$. VR_1 and VR_2 should be high, preferably with $VR_2 > VR_1$ and $R_3 = VR_1$. Of course, if no volume control is needed at this point VR_2 is simply the grid leak of the next valve, or is left out altogether if there is a D.C. path to earth through the input.

In adding one of these circuits before an existing A.F. amplifier it must be remembered that it acts as an additional stage and "motor-boating" may be experienced due to low-frequency feedback through the power supply unless the usual precautions for multistage amplifiers are observed.

Measuring Gear at Stockholm

Lost British Opportunities

(From a Correspondent)

AMERICAN, British, Czech, Danish, French, Finnish, Swiss, Swedish, Italian, Dutch, Norwegian and Austrian firms were all represented at the international exhibition of measuring instruments and laboratory equipment held in Stockholm from May 31 to June 3. It was surprising to find how little new there was in the radio and electronic field and how closely the Continental equipment resembled the British and American familiar designs. Six years of isolation have produced no major differences in technique.

The exhibition, like that of the Physical Society, covered a very wide range of equipment. On the fringe of the radio engineers' field were three exhibits of electron microscopes, one Swedish, one Dutch and one American, all giving very satisfactory demonstrations.

Generally speaking, it was all rather discouraging to a British visitor. Sweden is a "hard-currency" country and is anxious to buy equipment. Great Britain is supposed to be anxious to sell goods abroad, and the light-current electrical industry has an almost ideal export article, using relatively little material for a high price. The enormous capital investment in war-time "know-how" is an asset, but a wasting one, and every instrument sold now is some return on this capital. British manufacturers and their agents did not appear to be making the most of their opportunities in Stockholm.

There were some notable excep-

tions. Cambridge Instruments and Sullivan both showed equipment which was unmistakable and well maintained the British reputation in their field. Here indeed there was no question of our supremacy. Only Johnson Matthey and Avo were notable among the other exhibitors. Johnson Matthey showed a wide range of their materials, including ceramics, and silvered mica condensers, while Avo, represented by Svenska Radio A.B., had their full range of test equipment on view, and a very willing demonstrator. Only one stand showed any microwave equipment, and this was merely a jumble of magnetrons, T.R. gaps and bits of wave guides. A great opportunity was wasted here, for commonplaces of British technique are novelties in Sweden, and the future for navigational aids for shipping is a very great one.

The British Council stand deserves special mention in this note. Throughout the morning of my visit it was deserted, and a collection of out-of-date textbooks lay where they had fallen when dusted the day before. The main feature was a screen carrying photographs of early English navigational aids. There are some British devices later than Harrison's chronometer—indeed, there are so many that no one seems to know which to use. And there are some new books, too. Copies of *Wireless Engineer*, the *Journal of Scientific Instruments* and the *Proceedings of the Radio-location Convention of the I.E.E.* would have been fitting supporters.

R-C Oscillator Control

Design of Network for Single-Component Frequency Adjustment

By

B. J. SOLLEY

THE operation of an R-C oscillator is based upon the possibility of arranging a number of resistive and capacitive elements to form a network having, at one critical frequency, a phase shift of zero, or 180 degrees, from input to output.

The typical R-C oscillator, as

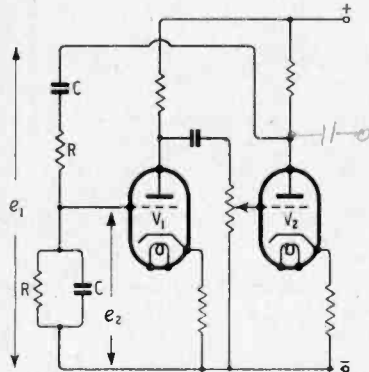

Fig. 1 Basic Wien bridge R-C oscillator.

represented by the two-stage regenerative amplifier of Fig. 1, embodies the well-known frequency-selective network derived from the Wien Bridge¹ the characteristic of which is that at the critical frequency $f = 1/2\pi RC$ there is zero phase shift, and a minimum attenuation of 1/3. The amplifier is accordingly designed to provide zero phase shift throughout the desirable frequency range and the gain is adjusted to slightly in excess of that required to sustain oscillations, i.e., 3 plus.

Among the principal advantages are good frequency stability and the possibility of obtaining a convenient frequency law by suitable choice of values. The outstanding disadvantage, however, with wide-range operation is the necessity for ganged tuning controls. In order to overcome this, the writer recently developed a form of composite network in which the tuning may be accom-

plished by means of a single potentiometer control.

The basis of this development may be understood by reference to Fig. 2, which shows two networks fed from the same source. The normal output terminals are bridged by a high resistance potentiometer P, and the output of the composite network is taken from the slider of the potentiometer. Suppose that network 1 has a critical frequency of 100 c/s, and that of network 2 is 1,000 c/s. When the slider is at its left extremity, point a, the transmission characteristic will be that of the left network. Similarly, when the slider is at point b the characteristic is that of the right-hand network. At any intermediate point the composite characteristic will be intermediate between the two extremes.

When such a network is embodied in an oscillator it will be

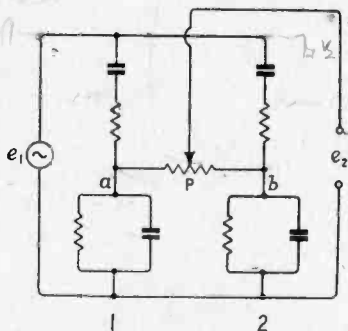

Fig. 2 Combination of two dissimilar frequency discriminating networks.

found that with a perfectly linear potentiometer the frequency law is exactly logarithmic, which is very desirable in many applications. At the centre of the potentiometer track, for example, the frequency will be the geometric mean of the two extremes. In the example above this would be $\sqrt{100,000} = 316.2$ c/s. Conversely,

by using a truly logarithmic potentiometer, the frequency law will be linear. The potentiometer must have a value in excess of about seven times the highest component resistor to ensure that the two component networks do not interact. Thus where the highest resistor in the network is $100k\Omega$ a potentiometer of $1M\Omega$ will be satisfactory.

It is tempting to suppose that by using two component networks with a large ratio of critical frequencies a very wide range could be accommodated. The matter may be elucidated as follows:—

The phase shift of the network is given by:

$$\tan \phi = \frac{1 - \alpha^2}{3\alpha} \text{ where } \alpha = f/f_0$$

f being any frequency and f_0 being the critical frequency.

The attenuation is given by:

$$\frac{\cos \phi}{3}$$

It can be shown that the locus of the vector ratio e_2/e_1 is a circle, as the frequency is varied from zero to infinity. The circle diagram of Fig. 3 has been constructed from the above expressions for phase and attenuation,

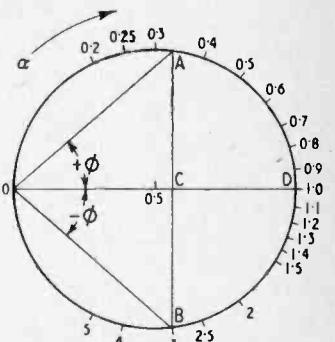

Fig. 3 Circle diagram for output vector of R-C network.

¹ "New Type of Selective Circuit and Some Applications," by H. H. Scott, *Proc. I.R.E.*, February, 1938, p. 226.

R-C Oscillator Control—

and from it the value of e_2/e_1 may be obtained for any value of α . At $\alpha=1$ the value is $1/3$ and the phase shift is zero, corresponding to the vector OD. For greater convenience this line OD has been divided into tenths. Let us take the case where the ratio of critical frequencies of the composite network is 9:1, e.g., left network 100 c/s and right network 900 c/s. If the input is connected to an audio generator operating at 300 c/s (i.e., the geometric mean), then the individual vectors of the networks will be represented by the lines OA and OB in the diagram with the slider at the centre of the potentiometer track. By joining the two vectors with the line AB the output at the slider will be given by the line OC. In this case, the output

automatic gain or regeneration control in order to compensate for the "dip" in characteristic over a wide range. For a smaller range the network ratios may be selected on the basis of some given permissible change in amplitude. For example, if the output is not to vary by more than 1 db, then the maximum frequency ratio will be seen from the curves to be 4:1. The greatest advantage will obviously be gained at the higher frequencies, where a given ratio embraces a larger absolute range.

fixed oscillator employing a simple network. Reference to Fig. 4 shows that for a frequency change of 20 per cent the output of the composite network changes

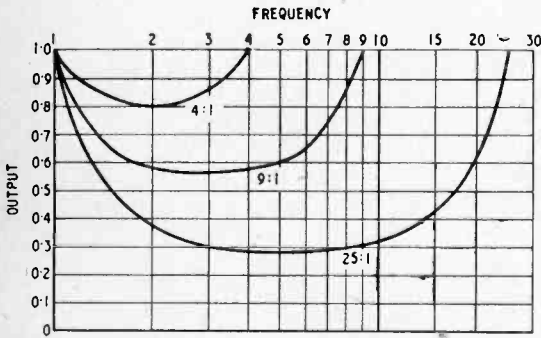

Fig. 4 In-phase output of composite network for three ratios of critical frequencies.

OC (in-phase) is 0.56 of maximum. As would be expected, this point gives the value of the lowest output for the whole interval between the two extreme positions. Thus, if the input is varied, at constant amplitude, from 100 to 900 c/s and the slider is made to follow to give no phase shift at all frequencies throughout this range, then the curve of output against frequency will be as shown in Fig. 4, labelled 9:1. Some other curves are also given to show how the output varies with frequency, at zero phase shift, for different ratios of critical frequencies in the component networks.

It will now be clear that for use in an oscillator the composite network must be associated with an amplifier having some form of

A further interesting development of this system is to use the network inverted; that is, to derive the output from across the series elements of the networks, as in Fig. 5. The circle diagram for this condition shows that the amplitude changes are much smaller than before. A set of curves for this

system is given in Fig. 6.

A more complicated arrangement, but one which has many points in its favour, is to use a composite network in the variable oscillator of a B.F.O., the

less than 0.5 per cent. Accordingly, in the case where the variable oscillator operates from 100 c/s to 120 c/s, the output would be practically constant. In such an arrangement it becomes a relatively simple matter to ensure the same stability for both oscillators. Consequently a very uniform output of low distortion is obtainable. Using a linear potentiometer, the frequency law over a 20 c/s range would be substantially linear because of the small range of frequency in the composite network.

With any of these arrangements employing the composite network the use of a tapped bridging resistor is quite practicable, and the work of computing the values between the taps is simple, since for a given frequency range the values required are related only to the total value of the bridging resistance.

Television Papers

REPRINTS in full of a large number of papers by R.C.A. authors are contained in "Television." Vol. III covers 1938-1941 and has 486 pages, while Vol. IV covers 1941-1946 in 510 pages. Summaries of papers not given in full are included, and in Vol. III there are also summaries of the papers in Vols. I and II which cover 1936-1938 and are out of print.

They are priced at \$2.50 each (\$1.50 paper bound) and are published by R.C.A. Review, Radio Corporation of America, R.C.A. Laboratories Division, Princeton, New Jersey, U.S.A.

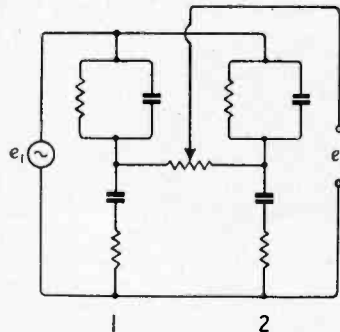

Fig. 5 Output taken across series-connected elements.

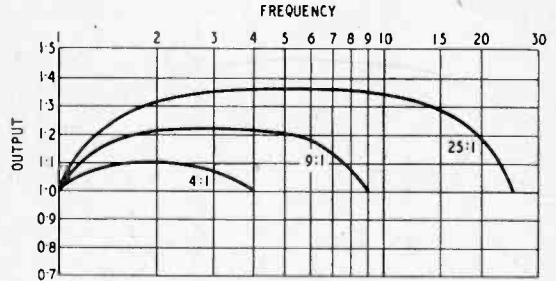

Fig. 6 In-phase output of inverted composite network.

TEST REPORT

Bush Television Model T91

*Straight Circuit for Vision:
Superhet for Sound*

IT can be seen from the circuit diagram that the receiver consists essentially of a straight vision channel with four R.F. stages, diode detector, and one V.F. stage. The sound channel is a superheterodyne fed from the second vision R.F. stage and comprises a triode-hexode frequency changer, one I.F. stage, duo-diode-triode detector, A.V.C. source and A.F. amplifier and pentode output valve. Noise suppressors are fitted in both channels.

A 9-in C.R. tube is used with electromagnetic deflection, the saw-tooth currents being generated by two two-valve time-bases.

The E.H.T. supply is taken from the mains with a transformer and valve rectifier and there are two rectifiers in the H.T. supply for the rest of the equipment.

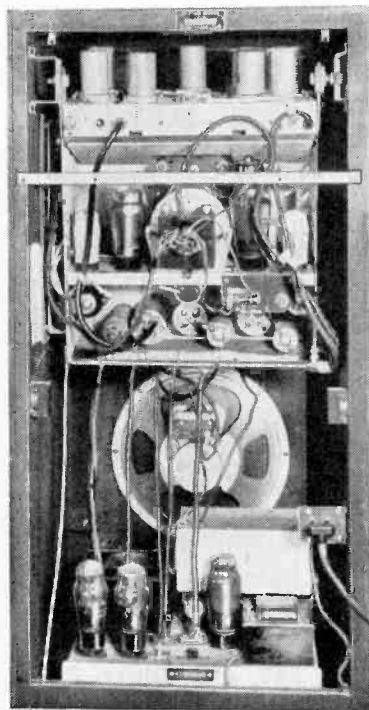

In the vision channel the interval-couplings are a mixture of single- and double-tuned circuit types, the latter having the form of "top end" capacitance-coupled band-pass filters. No unavoidable capacitance is added to the circuits and the circuits are trimmed by movable brass slugs fitted to the coils.

The detector and V.F. stage are conventional so far as the vision signal is concerned and the output at the anode of the V.F. valve is fed directly to the grid of the C.R. tube. A resistance is included in the cathode of the V.F. valve and the V.F. signal is developed here also but in opposite phase to that at the anode. A

Picture Size: $7\frac{1}{2}$ in \times 6 in.

Valves: 16+3 rectifiers.

Front Panel Controls: Sound volume, tone.
Side Panel Controls: Contrast, brightness, frame hold, line hold, tune.

Subsidiary Controls: Height, width, focus, linearity, vision, noise limiter, frame and line holds, local-distance switch.

Price: 56 gns.+£13 4s 3d purchase tax.

diode limiter is connected to the cathode and it produces positive-going sync pulses in its output which are fed through a differentiator and an integrator respectively to the line and frame time-bases.

The saw-tooth generators for both scans are thyratrons and they feed output pentodes which supply the saw-tooth deflecting currents to the coils through transformers. Negative feedback by means of variable resistors in the cathode lead of the line-scan amplifier is used to control the output and the resistor forms the picture-width control. On the frame amplifier

The power unit, which includes the sound output valve, is housed at the bottom of the cabinet.



the input is controlled by a potentiometer which forms the height control. Other variable resistors in the saw-tooth generators control the charging currents of the time-base capacitors and form the line- and frame-hold controls.

A limiter with an adjustable threshold is connected to the grid of the C.R. tube and it limits the input at the peak white level. It thus removes much of the nuisance value of ignition interference because it prevents the large white blotches which would otherwise occur through the defocusing of the spot on large peaks of interference. The limiter is a diode which is normally biased to be non-conductive but which conducts virtually to short-circuit the tube input when the grid becomes more positive than the peak white level.

The sound channel is unusual in being a superheterodyne with an intermediate frequency of 725 kc/s and the frequency-changer is fed from the output of the second vision-channel stage

Bush Television Model T91— of the R.F. amplifier. A trap circuit tuned to the oscillator frequency is coupled to the input circuit of the mixer.

The I.F. amplifier has one valve with two coupled pairs of tuned circuits arranged for a

tiometer on the detector output. On the vision side gain control, labelled "contrast," is provided by a variable resistor in the cathode circuit of the 2nd and 3rd R.F. stages, and the range of control is increased by the local-distance switch which enables an ad-

the volume control when a noise pulse of greater amplitude than that corresponding to the peak of 100 per cent modulation is received.

The two sound-channel controls are volume and tone, and the on-off switch is combined with the

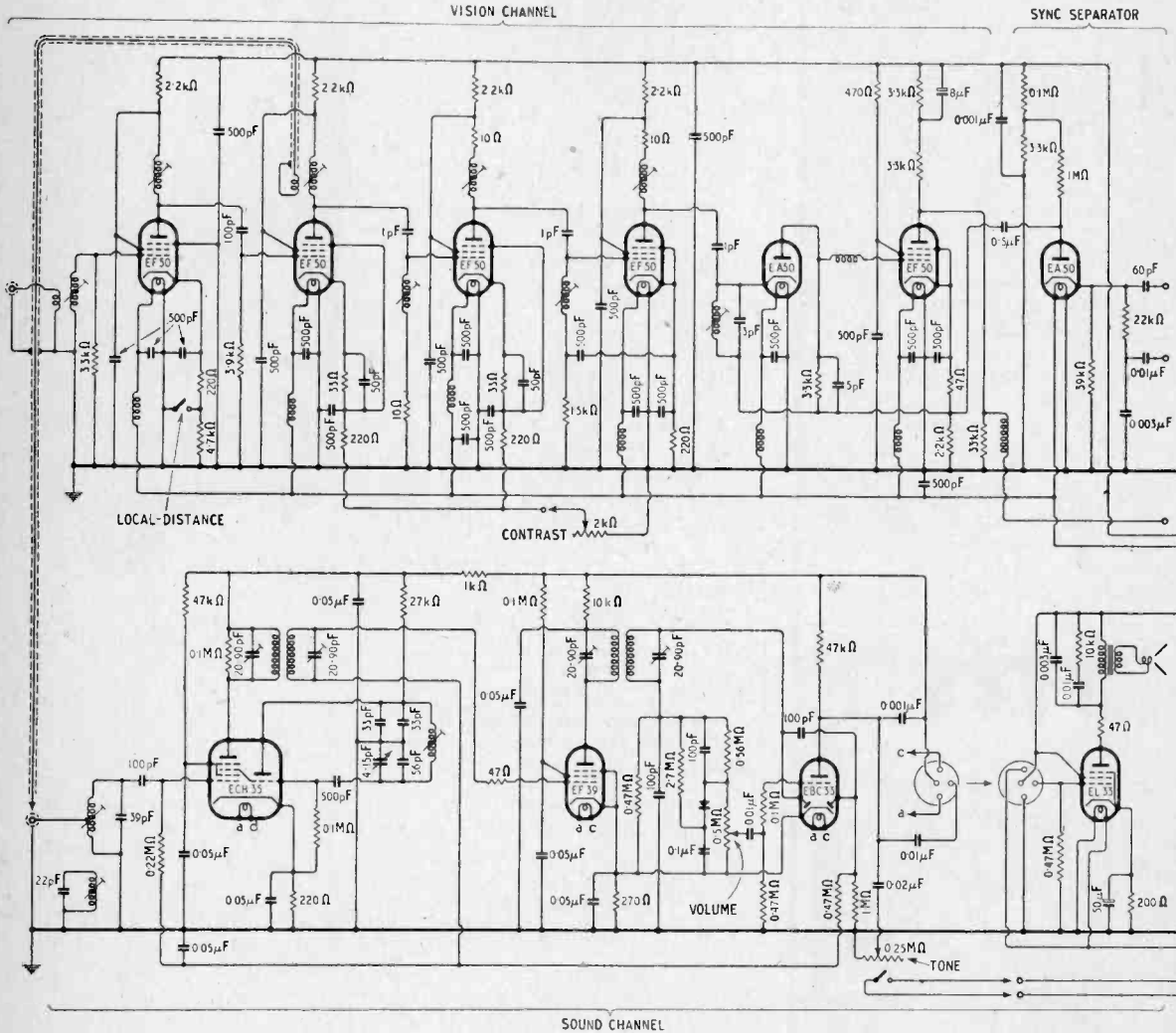

wide pass band to minimize the effects of oscillator drift. The oscillator tuning is largely pre-set, but a panel-mounted trimmer is provided to give a small range of control.

A duo-diode-triode acts as detector and first A.F. stage and also provides A.G.C. in the sound channel only. The sound volume control is the customary poten-

ditional resistor to be included in the circuit of the first stage for areas of high field strength.

The noise suppressor on the sound channel is of a conventional type and is automatically biased by the rectified D.C. output of the detector. It is arranged so that the metal rectifier is normally non-conductive, but it becomes conductive virtually to short-circuit

latter. They are mounted on the front between the speaker and the tube. The vision-channel controls are mounted at the side of the cabinet in a recess and are of two kinds. Those for normal user adjustment are fitted with knobs and others—subsidiary controls which need only occasional use—have no knobs but have saw-cuts in their shafts to take a screw-

Bush Television Model T91—

ever, rather tied up with the noise limiter adjustment and is complicated by the fact that this is an internal pre-set control. On setting up, the correct procedure

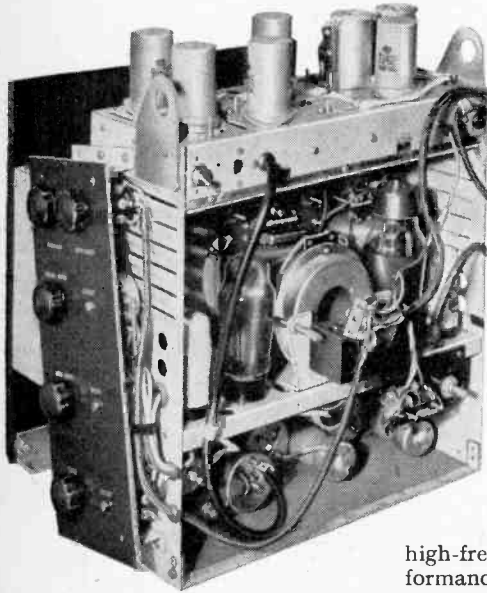

would normally be to back off the noise limiter and adjust Contrast and Brightness for the best picture. Then the limiter would be adjusted so that it just has no effect on peak white.

However, it is often found that some subsequent adjustment to the brightness control is needed to suit different programmes and the limiter does then seem to restrict the range available. When correctly adjusted the limiter is very effective in preventing defocusing of the spot under conditions of ignition interference and

it thus greatly reduces the visible effect of such interference. The slight increase in the complexity of adjustment is a small price to pay for this.

The focus is good and does not drift noticeably with changes of temperature, nor does the tuning of the sound channel which shows that the sound bandwidth is adequate in relation to the oscillator stability. The picture quality is excellent and the brightness adequate for day-light viewing.

On the sound side, the quality is good with an adequate

The vision channel is at the top with the sound channel at the bottom and the time-bases between them.

high-frequency response. The performance of the ignition-interference suppressor is very satisfying and reduces the major part of interference experienced to negligible proportions.

The set is housed in a cabinet standing 3ft $\frac{1}{2}$ in high and measuring 16 $\frac{1}{2}$ in wide by 15 $\frac{1}{2}$ in deep. The cowling over the C.R. tube projects 2 $\frac{1}{2}$ in at the rear. The set is in two units with plug interconnections, the sound output valve being housed on the power unit.

The equipment is intended for use with a coaxial feeder and an attenuator is available for areas of exceptionally high field strength.

of the order of 15 Mc/s; (c) a 2.5-kW dielectric heater for 5 to 20 Mc/s operation.

For investigating the external fields a modified Army set type R206 was used. This is a sensitive 11-valve superhet covering 550 kc/s to 30 Mc/s with provision for operation from a 12-V battery.

Equipment (a) was housed in a $\frac{1}{2}$ -in square mesh galvanized iron screened cubicle with a standard mains filter installed. The R.F. current in the work coil was 150 A.

Interference was recorded over an irregular area due no doubt to the presence of buildings. A field strength of 40 db above 1 μ V per metre was recorded over an area of approximately 0.0045 square mile and of 30 db over 0.27 square mile. The longest radius of the higher signal level was about 80 yards.

The set (b) was unscreened and its radiated field extended over a very considerable area, 70 db above the datum level being recorded over 0.013 square mile, 50 db over 0.11 square mile and 30 db over 2.4 square miles. Removing the load circuit gave only a small reduction in the intensity of the radiated interference.

Installation (c) was fully screened in a sheet-steel cabinet with filtered mains supply. Very little interference was recorded and a field strength of 20 db only affected a small area of 0.1 square mile.

The same equipment, but with extended unscreened work electrodes, produced a slight increase in local interference raising the area for a 20-db field to 0.15 square mile.

Conclusions drawn from these tests reveal that with unscreened equipment interference can be very severe, the 25-kW set (b), for example, producing 100 μ V per metre of interference over approximately 0.5 square mile at 15 Mc/s.

Radiation takes place from the R.F. generator and the work electrodes and any unscreened part of the apparatus carrying R.F. currents.

Harmonic frequencies are also radiated, the lower order ones can have amplitudes up to 50 per cent of the fundamental. Both amplitude and frequency modulation are present, the former mainly due to inadequate H.T. smoothing, the latter to effects of applied loads.

Quite simple screening produces a very marked reduction of the field intensity and the higher field strengths can be confined largely to the factory area.

This report, which is obtainable from the E.R.A. at 15, Savoy Street, London, W.C.2, is priced at 3/6.

Interference from R.F. Heaters

Investigations of External Fields

A REPORT recently issued by The British Electrical and Allied Industries Research Association reveals some interesting facts on the nature and extent of the interference that may be caused by industrial R.F. heating equipment, especially when the apparatus is inadequately shielded.

The report does not cover mains-

borne interference but only that produced by radiation from the R.F. generator and the auxiliary equipment.

Investigations were undertaken on three different installations, (a) a 45-kW induction heating plant generating R.F. power at about 600 kc/s; (b) a dielectric heating set delivering 25 kW at frequencies

If a 12Z3 you'd fix

★ BRIMARIZE

with a 1D6

There are two suitable alternatives to the 12Z3—the 1D6 and the 25Z4G; both need a change of socket. The 12Z3 has a 12.6 volt heater whereas those of its replacement types have 25 volt, necessitating a small decrease in line cord resistance. All three types are half-wave rectifiers.



12Z3

PUNCH HOLES HERE

INSTRUCTIONS: Punch holes where indicated and cut away this portion. Cut out and file them in the order in which they appear. This column will then give you a quick reference index.

TYPE	CHANGE SOCKET		CHANGE CONNECTIONS		OTHER WORK NECESSARY	PERFORMANCE CHANGE
	FROM	TO	FROM OLD SOCKET	TO NEW SOCKET		
12Z3						
1D6	UX 4-Pin	UX 6-Pin	Pin 1 " 2 " 3 " 4	Pin 1 " 2 or 5 " 4 " 6	Decrease line cord by 40 ohms.	NEGLIGIBLE
25Z4G	UX 4-Pin	INT/ OCTAL	Pin 1 " 2 " 3 " 4	Pin 2 " 3 or 5 " 8 " 7	Decrease line cord by 40 ohms.	NEGLIGIBLE

BRIMAR
RADIO VALVES

★ BRIMARIZING—a service which first-class dealers can offer those customers whose radio sets have been designed round valves which are in short supply.

STANDARD TELEPHONES AND CABLES LIMITED, FOOTSCRAY, SIDCUP, KENT.

WATCH THIS SERIES FOR THE BEST ADVICE

6

Judge your success by an ffr test



Whether you build a high fidelity radiogram or just a straight record reproducer, give it a fair test with an ffr record. Don't ask it to reproduce frequencies that aren't there. Decca ffr recordings cover from 30 to 14,000 cycles per second. Any of the following records made the Decca ffr way will instantly tell you how far you have reached that high degree of fidelity which was your aim. If your local dealer cannot supply you with these ffr records please write direct to us.

Full Symphony Orchestra

Symphonie Fantastique, Op. 14. *Fantastic Symphony (Berlioz)*
The Concertgebouw Orchestra of Amsterdam
Conductor: Eduard van Beinum K 1626-31
Auto. couplings AK 1626-31

Solo piano and Full Symphony Orchestra

Eileen Joyce (*piano*)
Symphonic Variations (Cesar Frank)
with L'Orchestre de la Société du Conservatoire de Paris
Conductor: Charles Münch K 1587-8
Auto. couplings AK 1587-8

Contralto soloist and Full Symphony Orchestra

Lieder eines Fahrenden Gesellen (Gustav Mahler)
No. 1. Wenn mein Schatz Hochzeit macht K 1624
No. 2. Ging heut' Morgen über's Feld
No. 3. Ich hab' ein glühend Messer
No. 4. Die zwei blauen Augen K 1625
Eugenia Zareska (*Contralto*) with
The London Philharmonic Orchestra
Conductor: Eduard van Beinum
Auto. couplings AK 1624-25

Orchestra and Chorus

Faust—Waltz and chorus (Gounod)
Romeo and Juliet—Swift hours of pleasure (Gounod)
The B.B.C. Theatre Orchestra and Chorus
Conductor: Walter Goehr K 1599

Organ Solo

Toccata and Fugue in D Minor (J. S. Bach)
Jeanne Demessieux (*Organ*) K 1635
Recorded at St. Mark's Church, North Audley Street, London

Operatic Soloists and Full Orchestra

Boris Godounov—Nursery scene (Moussorgsky)
Derek Barsham (*Boy Soprano*)
Gladys Palmer (*Contralto*) Norman Lumsden (*Bass*)
with The London Symphony Orchestra
Conductor: Stanford Robinson K 1601
Recorded at Kingsway Hall, London

Violin and Piano

Polanaise Brillante No. 2, Op. 21 (Wieniawski)
Ida Haendel (*violin*) with piano accompaniment by
Adela Kotowska K 1213

Rumba Band

Tell me again (Dime Porque) Beguine
Vocalist: Ronald Magar
Quimbamba (Canto Negroid) F 8757
Vocalists: Edmundo Ros and Choir
Edmundo Ros and his Rumba Band
(at "The Bagatelle," London)

Swing Band

Mountain Greenery Experiment F 8756
Ted Heath and his Music

Decca

living music

The Decca Record Company Limited, 1-3 Brixton Road, London, S.W.9

Broadcast Reception for

EXTENDED listening tests in school classrooms have shown that a far more exacting specification for the radio receiver and its associated equipment than is generally found in the ordinary domestic set is desirable for educational purposes. An effective audible range of from about 60 c/s to 12,000 c/s is required from the sound-amplifying equipment if speech and music are to appear sufficiently natural to prevent aural fatigue and the consequent wandering of the pupils' attention. Over this range of frequencies the response must be linear and with a total harmonic distortion not exceeding about 2 per cent.

Given these desirable qualities, the actual intensity of sound required adequately to serve a large classroom becomes surprisingly low, and this is an important factor since it prevents the distraction of attention in adjoining classrooms.

The requirements at different schools vary so widely that it is very doubtful if any one type of receiving equipment, or any standardized layout of the units, could be made to satisfy them all. The issue is also complicated by the fact that facilities for gramophone reproduction are also required in many cases. In these circumstances a number of different arrangements must be considered. Details of three typical ones are as follows:—

System No. 1.—In this system the radio receiver is located in a central radio room and the output taken at a low audio level to a portable amplifier in the classroom. The receiver can be switched on and off by remote control and each classroom is thus wired with a suitable control line and a balanced pair cable of about 300 ohms for the low-level audio output from the radio set. This low-level signal is then amplified in the classroom and the volume adjusted on the amplifier for the prevailing conditions.

If recorded matter is to be employed a portable gramophone unit is plugged into the amplifier.

Schools

Description of an "Approved" Installation

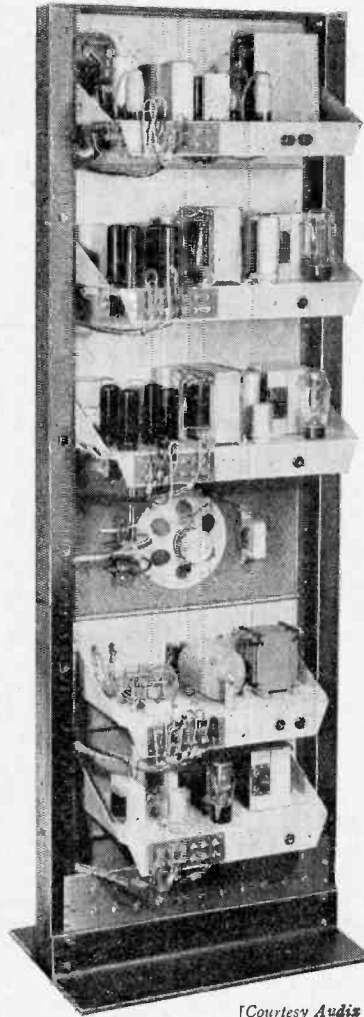

[Courtesy Audis

Rear view of the central receiving equipment. At the top is the radio receiver, below are the two amplifiers, then follow a local monitoring loudspeaker and finally contactor and power units.

System No. 2.—With this system all the apparatus is located in a central radio room. It comprises a radio receiver, radio amplifier, gramophone amplifier and contactor unit which switches the radio or gramophone output as required to the appropriate classroom on operation of the remote switching there.

In the classroom is a loudspeaker and a remote control unit, the latter being fitted with a socket for plugging in a gramophone unit.

In this system the amplified radio signal is fed to the classroom, while if gramophone reproduction is required the output from the gramophone unit is fed from the classroom to the central amplifier, then back again at high level to the classroom loudspeaker.

Unless duplicate gramophone amplifiers are installed only one classroom can have recorded matter, but all fitted classrooms can, of course, have the radio programme, which condition also applies to the No. 1 arrangement.

System No. 3.—This is a modification of No. 2 and employs centralized equipment, but has, in addition, a central control point where any classroom can be switched to the radio programme or to a gramophone recording. A feature of this installation is the provision at the central control for a microphone, the output of which, suitably amplified, can be relayed to any particular classroom, or to all at the same time. The only control in the classroom is of the loudspeaker output.

Experimental Prototype.—Comprehensive radio and sound amplifying equipment has recently been installed at Rowland Hill School, Tottenham, London, by Audis, of Sheldrake House, London, S.E.5. It was designed in collaboration with the Central Council for School Broadcasting, and, apart from serving the needs of this particular school, was intended to form a basis on which designs to meet the varying requirements of other educational authorities may be built.

In conception it follows very closely the design of the second installation plan described, as all the main equipment is centralized and only a loudspeaker and control unit fitted in each of the 10 classrooms wired into the system.

One addition has been made, and that is the provision of a separate amplifier in the school assembly hall giving a somewhat larger power output than would be obtainable from the classroom equipment. It provides for radio, gramophone or microphone reproduction, taking the radio programme from the school central receiver and the recorded matter from a self-contained gramophone unit. A schematic layout of this installation is reproduced here.

Radio Unit.—Rack construction is adopted for the central equipment, which consists of a five-valve superheterodyne receiver, radio and gramophone amplifiers, power supply units and relay panel. The radio receiver covers the medium and the long waves only, using a normal tuning system, and has provision also for four pre-tuned programmes, three in the medium and one in the long wavebands. These are selected by a rotary switch. An unusual feature is the incorporation of a valve voltmeter as a tuning meter, it being considered that far more accurate tuning is effected by this means than by any other.

The receiver includes one R.F.

diode triode providing detection, A.G.C. and a stage of A.F. amplification. The output is taken from the cathode circuit of this valve, which has an output impedance of 300 ohms. A tunable filter, covering a range of 7 to 14 kc/s, is connected in the

[Courtesy Audix

Typical classroom installation comprising loudspeaker, wall-mounted control unit and portable gramophone.

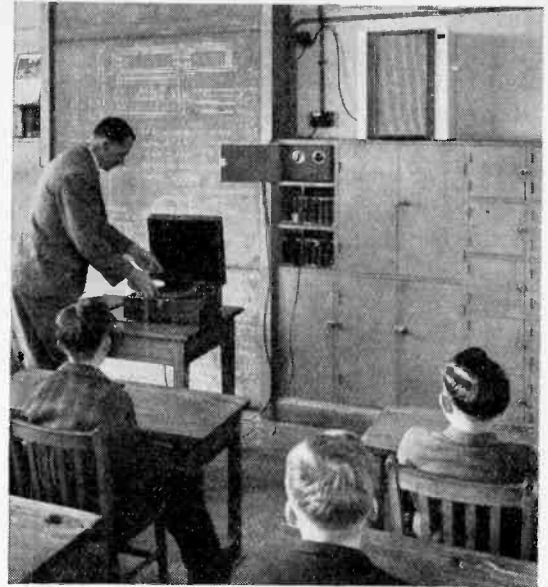

grid circuit of the last valve for suppressing any adjacent-channel whistles that may occur as a result of the wide I.F. bandwidths.

Radio and Gramophone Amplifiers.—Mounted in the rack are two power amplifiers capable of 20 watts audio output each, one for radio and the other for gramophone. They are similar in that both employ four 6L6 valves in a parallel push-pull output circuit with negative feedback. The driver stage is a double-triode functioning as a phase splitter.

In the radio amplifier the phase splitter is preceded by one stage

Switching on and off of the radio receiver and the gramophone amplifier is normally effected in the classrooms through the remote control unit. This connects to what is described as a contactor panel on the equipment rack which provides the 24-volt D.C. supply needed for operation of the various relays. A low voltage only is thus passed over the control wire circuits and the insulation problem is thereby considerably simplified.

As previously explained, each classroom in the Rowland Hill School installation has a control panel and a loudspeaker as permanent fittings. This unit serves three functions: remote switching of the central apparatus, audio power attenuation in the classroom and provision for feeding into the equipment the output from a gramophone unit. The volume attenuator, a constant impedance network as looked at from the line, provides 4 steps of 2 db each, 5 steps of 3 db and 3 steps of 5 db.

Loudspeaker Housings.—Some interest attaches to the loudspeakers as these are not merely chassis units assembled in cabinets. In order to preserve the good characteristics of the electrical part of the installation a special design of housing is used. This behaves as an acoustic chamber and extends the usable range of the loudspeaker below

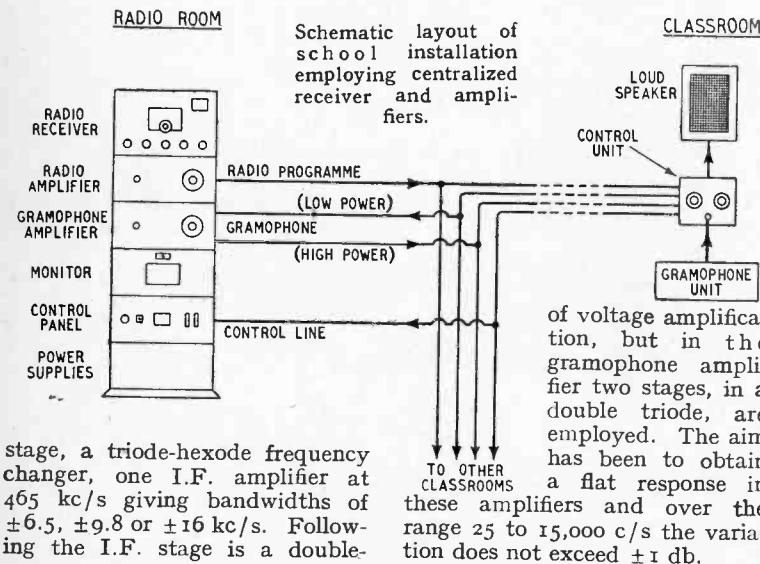

Broadcast Reception for Schools—that which would be attainable with a baffle of comparable size. A linear response of from 60 to 8,000 c/s is claimed for this acoustical system and a demonstration fully confirmed that an extremely wide range is covered without any noticeable trace of distortion. The loudspeaker unit used is a 12in moving-coil type capable of handling 10 watts.

Normally the classroom atten-

tators are set at position eight, giving a power level 8 db below the maximum of 2 watts available. This gives a maximum power of 300-milliwatts only. Although heavy-duty loudspeakers are employed they can be justified on the grounds that they contribute to the good results obtained, since no part is stressed, while their high efficiency makes the use of such low power practicable.

addition a figure in brackets is given for the use of those whose primary interest is the exploitation of certain frequency bands, and this indicates the highest frequency likely to be usable for about 25 per cent of the time during the month for communication by way of the regular layers:—

Montreal :	0000	15 Mc/s	(20 Mc/s)
	0100	11 "	(17 "
	0900	15 "	(20 "
	1000	17 "	(24 "
	1200	21 "	(31 "
	2100	17 "	(25 "
	2300	15 "	(21 "
Buenos Aires :	0000	17 "	(23 "
	0100	15 "	(22 "
	0300	11 "	(19 "
	0900	15 "	(20 "
	0900	21 "	(28 "
	1000	26 "	(37 "
	2000	21 "	(20 "
	2200	17 "	(24 "
Cape Town :	0600	17 "	(23 "
	0100	15 "	(22 "
	0300	11 "	(21 "
	0500	15 "	(22 "
	0800	17 "	or 21 Mc/s (26 "
	0800	26 "	(39 "
	1900	21 "	(30 "
	2100	17 "	(25 "
Chungking :	0000	11 "	(17 "
	0400	15 "	or 17 Mc/s (21 "
	0600	21 "	(29 "
	1000	26 "	(35 "
	1400	21 "	(27 "
	1600	17 "	(23 "
	1800	15 "	(20 "
	2100	11 "	(18 "

Short-wave Conditions

Expectations for September

By T. W. BENNINGTON

(Engineering Division B.B.C.)

DURING July the average maximum usable frequencies for these latitudes were about the same as those for June, both for day and night. Daytime working frequencies were, therefore, relatively low—except for north/south paths—and those for night-time relatively high. A very considerable amount of Sporadic E occurred during the month, and medium-distance communication on very high frequencies by way of this region was frequently possible.

There was relatively little ionosphere storminess during July, though one severe disturbance occurred during the period 17th-20th. Short-lived storms of minor intensity took place on 2nd, 23rd and 29th. Of the several "Dellinger" fade-outs which occurred, that at 1430 on the 23rd appears to have been the most severe.

Forecast.—There should be a very considerable increase in the daytime M.U.F.s during September, for, though it is problematical as to whether or not the sunspot maximum will have been passed by then, solar activity will in any case be very high, and the Northern Hemisphere seasonal effect will also tend to produce high ionisation. Night-time M.U.F.s should be a little lower than during August.

Working frequencies for long-distance transmission paths should therefore be exceptionally high by day, and the higher frequencies—like 28 Mc/s—should be usable for long periods in most directions from this country. Frequencies as high as 17 Mc/s should remain usable till after midnight on many circuits, and those below 11 Mc/s should not be

really necessary at any time during the night.

Though the E and F₁ layers may control transmission over medium distances for an hour or two around noon, this effect will be of much shorter duration and much less marked than during the past few months.

Sporadic E is likely to decrease sharply in the frequency of its occurrence, and little communication over medium distances is likely to take place by way of this region.

Below are given, in terms of the broadcast bands, the working frequencies which should be regularly usable during September for four long-distance circuits running in different directions from this country. Times are G.M.T. In

There is usually some increase of ionosphere storminess during September, and some periods of poor short-wave communication must be anticipated. At the time of writing it would appear that disturbances are more likely to take place during the periods 1st-3rd, 9th-12th, 16th-19th, 22nd-23rd and 28th-30th than on the other days of the month.

Record Storage Unit

A SIMPLE record storage device known as the IM/RAK has been produced by Alfred Imhof, 112-116, New Oxford Street, London, W.C.1. It consists of a light metal frame into which are inserted a series of semi-circular spring steel wires, which are coated with P.V.C. The records slip vertically between the wires and rest on P.V.C. pads. Up to fifty 10-inch or 12-inch records can be accommodated, and the spaces are numbered for quick reference. The price of the unit is 29s 6d and an optional dust-proof plastic cover is available at 7s 9d. Purchase tax is additional to these prices.

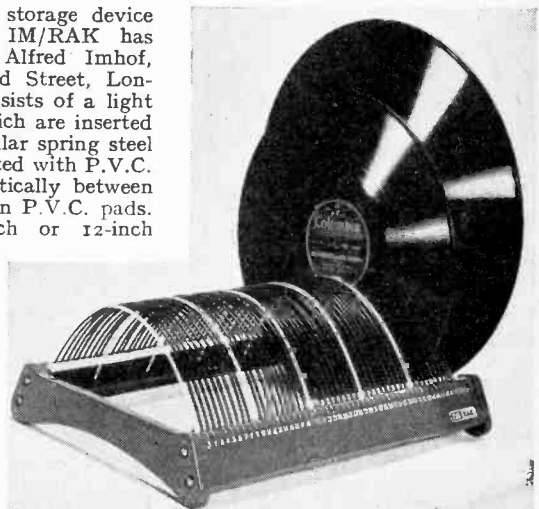

Television Receiver Construction

7.—The Receiver Unit

A CHOICE between the straight set and the superheterodyne for television reception is by no means easy at the present time. Each has its own peculiar merits and its shortcomings, but they are very evenly balanced and under the present conditions of a single vision transmitter at 45 Mc/s there is really very little to choose between them.

In the straight set all pre-detector valves pull their full weight as amplifiers, whereas in

attenuation at 41.5 Mc/s; the change of frequency from the pass region to the sound channel is only 1 part in 84.

In a superheterodyne the pass-band might well be 16 Mc/s to 10 Mc/s with the sound channel at 9.5 Mc/s and the change of

These points do not arise at present because the only vision transmitter operates at 45 Mc/s. When the Birmingham station is opened, however, the position may well be different. No announcement of its operating frequencies has yet been made, but if they are much higher than the present ones a superheterodyne

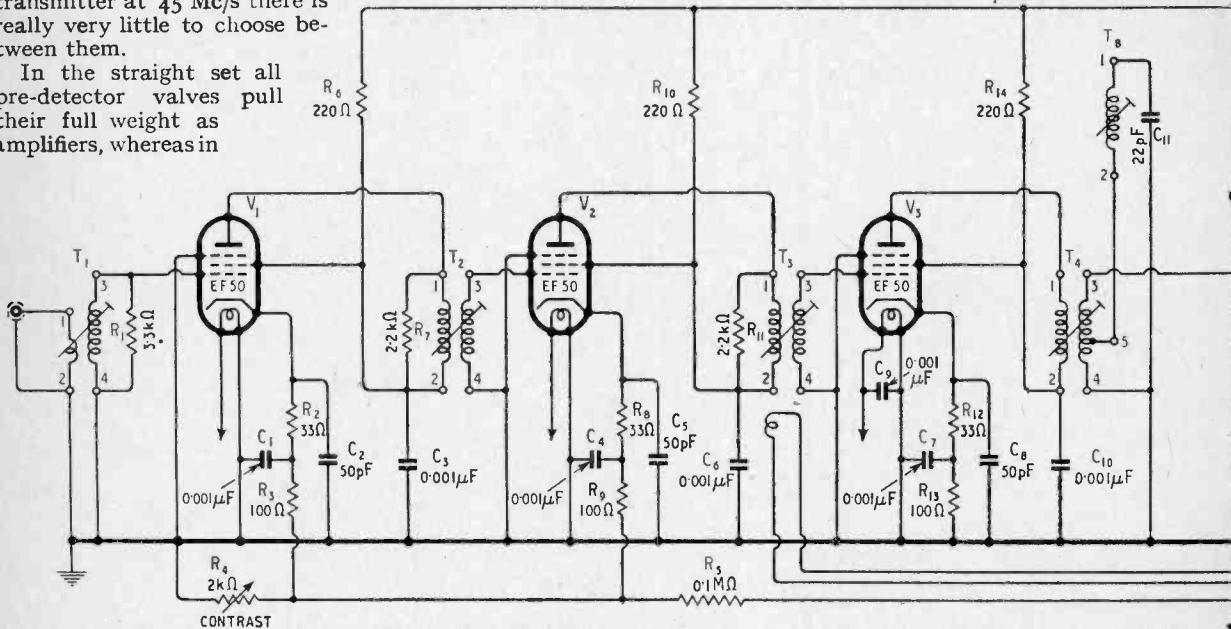

the superheterodyne the frequency-changer may use two valves and provide a gain of no more than one-third of that of an amplifier. There are no problems of oscillator drift or radiation to be solved in the straight set and it is free from I.F. harmonic feedback troubles, second-channel interference and I.F. pickup.

It is easier to achieve stability with the superheterodyne than with the straight set but there is no serious difficulty with the latter at 45 Mc/s. The real drawback of the straight set lies in achieving the required bandwidth combined with sufficient selectivity to avoid interference from the sound channel on 41.5 Mc/s. Ideally a response from 48 Mc/s to 42 Mc/s is required with high

frequency is then 1 part in 20. The separation of the two channels by rejector circuits is then easier.

At the present time it is just possible to obtain adequate sound channel rejection with the straight set. If television transmissions were on a higher frequency than 45 Mc/s it would probably become impracticable to secure it. Thus, if the vision transmitter were at 65 Mc/s with a sound channel at 61.5 Mc/s the sound channel rejection would have to be obtained for a frequency change of only 1 part in 122. This alone would almost certainly necessitate the adoption of the superheterodyne. In addition, the lower input resistance of valves at such a frequency might well render its use advisable.

receiver may well become almost a necessity.

There is a further point. If more than a single television transmission is receivable in any area then some form of station selection mechanism becomes necessary. This alone almost forces one to the superheterodyne because station selection can be achieved with changes to at most three circuits, whereas in the straight set the tuning system would have to operate on at least nine circuits!

All this lies in the future, for the present Alexandra Palace transmissions are guaranteed for some years to come. For their reception the straight set is adequate and is simpler than the superheterodyne except, perhaps,

tion

when the highest sensitivity is needed. The set described in this article is accordingly of this type. In *Wireless World* for November 1946, when giv-

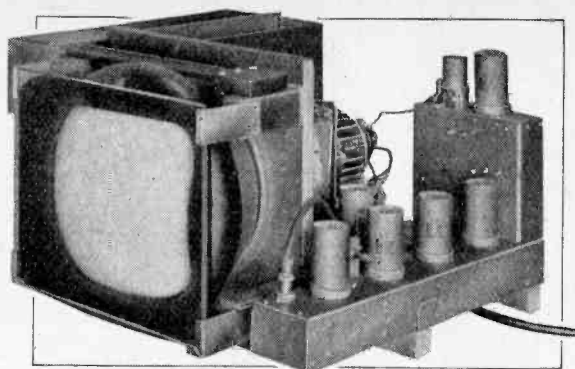

field strengths in which ignition interference is not usually a serious problem. Accordingly no suppression circuits are included.

The second receiver, to be described later, will be of higher sensitivity and will be designed primarily for use towards the limits of the service area. As ignition interference can be very serious in such areas, it will include limiters to minimize its effect. It will be a superheterodyne—partly because of the higher sensitivity required and

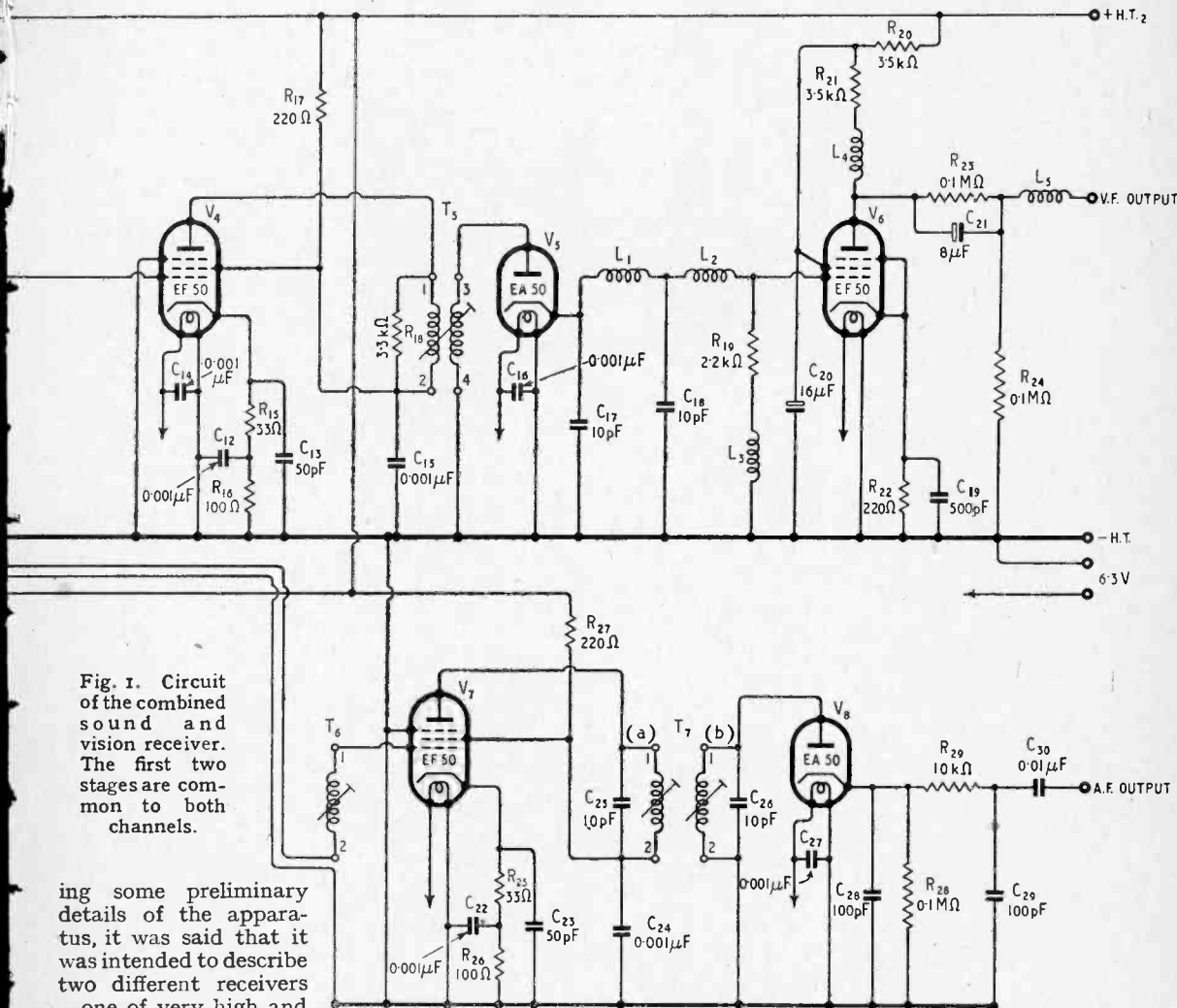

Fig. 1. Circuit of the combined sound and vision receiver. The first two stages are common to both channels.

ing some preliminary details of the apparatus, it was said that it was intended to describe two different receivers—one of very high and the other of medium sensitivity. The present set is the latter and represents probably the simplest satisfactory form of receiver. The aim in design has been to obtain the

widest bandwidth consistent with adequate sound-channel rejection with a simple form of construction.

The set is intended mainly for use in areas of moderate to high

partly to permit its ready modification for signal frequencies other than 45 Mc/s.

The present straight set will meet most, but not all, present

Television Receiver Construction— requirements. As a conservative estimate of its capabilities it will be entirely satisfactory in most suburban areas up to 10 miles from Alexandra Palace, except possibly in a few blind spots, or where the aerial is close to a main road carrying heavy traffic. The

with pickup terminals which can be employed. The output obtainable is of the same order as that of the average magnetic pickup.

At a frequency of 45 Mc/s the chassis material is important, as also are the connections to it and their disposition. On account of its high conductivity, copper is

valve. In conjunction with the grid-cathode capacitance of the valve, this has the effect of increasing the effective input resistance of the valve to something like 19 k Ω , and at the same time stabilizes the input capacitance so that it changes negligibly with a change of grid bias.

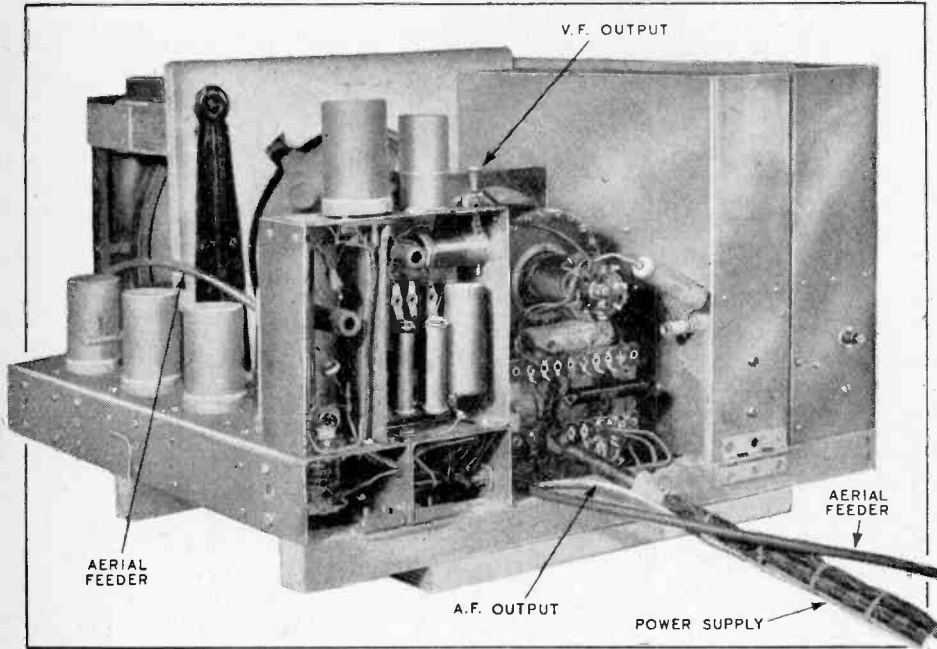

A rear view of the complete receiver with the C.R. tube and both time-base units. All units are mounted on hinges so that access to their interiors is easily obtained.

sensitivity is probably adequate for ranges of 15–20 miles or even more when the aerial is on high ground. Ignition interference may become troublesome at such ranges, however, and it is hoped to describe in a further issue suitable limiters which can be added in such cases.

The circuit diagram is given in Fig. 1 and it will be seen that on the vision side there are four R.F. stages, a diode detector and one V.F. stage. The first two R.F. stages are common to vision and sound; the sound signal is picked out of the coupling between the second and third stages and fed to a further R.F. stage for sound only, which in turn feeds a diode detector.

The sound channel stops at the detector, for it is felt that most people have an existing A.F. amplifier or a broadcast receiver

necessary for the chassis. Copper-plated steel would probably be satisfactory, but is usually harder to obtain than copper sheet. It is necessary to solder earth points on valveholders directly to the chassis with very short leads; this is not difficult if tackled in the right way and will be dealt with later.

Referring to the circuit diagram, it will be seen that EF50-type valves are used throughout for all amplifiers and that the bias circuits of the R.F. valves appear somewhat unusual. In the case of V_4 , for instance, there is a network R_{15} , C_{13} , R_{16} and C_{12} in the cathode lead. Bias is provided by R_{15} and R_{16} totalling 133 Ω ; R_{16} is bypassed to R.F. by C_{12} of 0.001 μ F. Consequently, at radio-frequency there is effectively the impedance of R_{15} (33 Ω) and C_{13} (50 pF) in parallel in the cathode lead of the

This last point is important in the case of V_1 and V_2 , for with these the bias is variable by means of R_4 to obtain gain control (contrast).

The screens and anodes are fed at the same voltage and have common decoupling components; viz., R_{17} and C_{15} in the case of V_4 . The intervalve couplings are effectively single-tuned circuits with their resonance frequencies staggered about the mid-band frequency of 45 Mc/s in order to obtain the required bandwidth. They are double wound so that the anode and grid return leads can

be taken directly to the appropriate valves. If a single winding were used with a coupling capacitor this would not be possible, and it has been found that the increase in R.F. currents in the chassis materially reduces stability.

Details of the coils and the actual resonance frequencies are given later. The input is built to match a 75- Ω coaxial cable, and this is necessary. The use of a twin-feeder will cause instability at full gain because it is not screened; a screened twin-wire feeder might be satisfactory, but it has not been tried.

The first circuit T_1 is damped by the transferred impedance of the feeder, the resistor R_1 of 3.3 k Ω and the input resistance of V_1 . It is tuned mainly by the input capacitance of V_1 .

The second circuit T_2 is damped by the resistor R_7 of 2.2 k Ω and

the input resistance of V_2 . The capacitances effective here are mainly the output capacitance of V_1 and the input capacitance of V_2 , but of course the wiring capacitance and the self-capacitance of the coils have quite an appreciable effect. Because of the higher capacitance the inductance of T_2 is lower than that of T_1 .

The following circuits in the vision channel are substantially the same, but in T_3 a single-turn coil is coupled to the main windings and is connected in series with T_6 to form the first sound-channel circuit. This plays a dual role. In the first place it feeds the sound signal into the sound amplifier, and in the second it acts as a rejector of the sound signal in the vision amplifier.

A further rejector is provided in T_4 and is the circuit T_8 with C_{11} and is connected to a tapping on the secondary of T_4 at one turn from the earthy end. No deliberate damping is used on T_4 . A diode detector is used and direct-coupled to the V.F. stage through a double filter L_1 , L_2 of resonant chokes. The diode load is R_{19} of $2.2\text{ k}\Omega$ with a correction choke L_3 in series. The V.F. valve is biased by R_{22} , which is shunted by C_{10} to give a rising response at very high frequencies to compen-

sate in some measure for the tailing response of the R.F. circuits.

Direct coupling to the cathode of the C.R. tube is adopted with a double-compensation circuit involving the two inductances L_4 and L_5 .

On the sound side there is one R.F. stage V_7 feeding a diode detector V_8 through a pair of coupled circuits which together form T_7 . They are loosely coupled and as, with the narrow bandwidth needed, there is no difficulty in obtaining sufficient impedance for the required amplification, 10-pF capacitors are added to the circuits to reduce the L/C ratio and improve the selectivity.

It will be noticed that V_3 , V_4 , V_5 and V_8 have 0.001- μF capacitors connected across their heaters. These are not necessarily for stability since the amplifier is quite stable without them. They are used to prevent interaction

between the sound and vision channels. Without them it is found that the sound signal is carried by the heater wiring into the vision channel and vice versa.

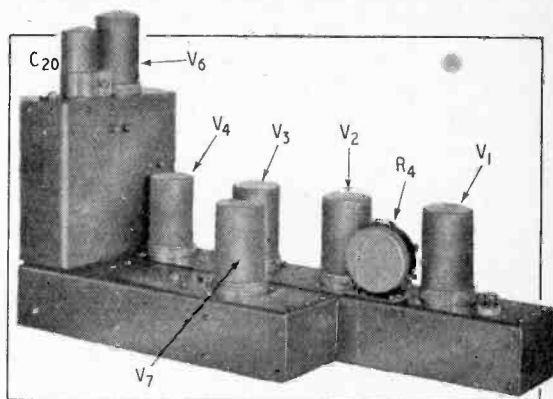

A general view of the receiver unit is shown above and the under view, below, clearly shows the arrangement of the main parts.

Data on the coils and detailed photographs of the chassis showing the R.F. wiring—a very important item—will be given next month. In the meantime it may be said that the chassis are of No. 20 gauge copper sheet with cross-screens of No. 26 gauge copper.

The vision channel chassis measures 14 in. by 2½ in wide by 1½ in high, while the sound channel

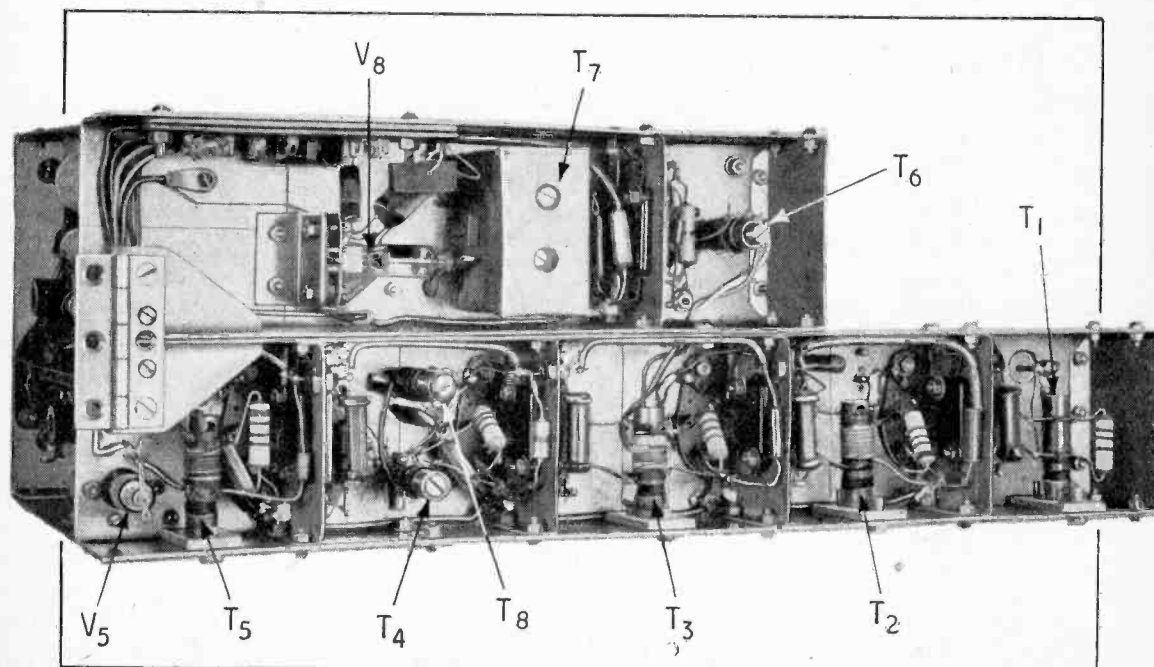

chassis is gin long, but otherwise the same. The rear section, erected on the main chassis, can

be of brass or copper, and is 5in wide by 1½in deep and stands 4½in above the main chassis.

LIST OF PARTS

Resistances

R ₁ , R ₁₈ ...	3.3 kΩ, ½ W	Erie
R ₂ , R ₈ , R ₁₂ , R ₁₅ , R ₂₅ ...	33 Ω, ½ W	Erie
R ₃ , R ₉ , R ₁₃ , R ₁₆ , R ₂₆ ...	100 Ω, ½ W	Erie
R ₄ ...	2 kΩ, 3 W, variable, wire-wound.	Reliance Type TW
R ₅ , R ₂₃ , R ₂₄ , R ₂₈ ...	100 kΩ, ½ W	Erie
R ₆ , R ₁₀ , R ₁₄ , R ₁₇ , R ₂₂ , R ₂₇ ...	220 Ω, ½ W	Erie
R ₇ , R ₁₁ , R ₁₉ ...	2.2 kΩ, ½ W	Erie
R ₂₀ , R ₂₁ ...	3.5 kΩ, 2 W	Erie
R ₂₉ ...	10 kΩ, ½ W	Erie

Capacitors

C ₁ , C ₃ , C ₄ , C ₆ , C ₇ , C ₁₀ , C ₁₂ , C ₁₅ , C ₂₂ , C ₂₄ ...	0.001 μF, 350 V, mica	T.C.C. Type M
C ₂ , C ₅ , C ₈ , C ₁₃ , C ₂₃ ...	50 pF, silvered mica	T.C.C. Type CM23
C ₉ , C ₁₄ , C ₁₆ , C ₂₇ ...	0.001 μF	Hunts Type L1/2 (M.O.)
C ₁₁ ...	22 pF, silvered mica	T.C.C. Type CM23
C ₁₇ , C ₁₈ ...	10 pF ceramic or silvered mica	T.C.C. Type CC30y or CM23
C ₁₉ ...	500 pF, 350 V, mica	T.C.C. Type M
C ₂₀ ...	16 μF, 500 V, electrolytic	Dubilier Drilitic CT1650
C ₂₁ ...	8 μF, 500 V, electrolytic	Dubilier Drilitic BR850
C ₂₅ , C ₂₆ ...	10 pF, silvered mica	T.C.C. Type CM23
C ₂₈ , C ₂₉ ...	100 pF, silvered mica	T.C.C. Type CM23
C ₃₀ ...	0.01 μF, 350 V, tubular paper	T.C.C. Type 345

Valves

V ₁ , V ₂ , V ₃ , V ₄ , V ₆ , V ₇ ...	—	Mullard EF50
V ₅ , V ₈ ...	—	Mullard EA50

Miscellaneous

Coaxial cable plug ...	—	Belling-Lee Type L.604/P
Coaxial cable, socket ...	—	Belling-Lee Type L.604/S

the larger Model 1046G reviewed in our October, 1946, issue. The price is £115 10s, plus £24 14s 1d purchase tax.

A console model of the Murphy "baffle" set, Model 122C, keeps the general idea of large frontal area and shallowness back-to-front. Based on the A122, which is the successor to the A104 (reviewed in our Dec., 1946 issue), it has a similar four-valve plus rectifier superhet circuit covering short, medium and long waves, but does not include the optical tuning system for short waves used in the A104. Separate scales for the three wavebands are placed end-to-end in an aperture in the top of the cabinet. The A122C employs a 10-inch loudspeaker and costs £33 12s 3d including purchase tax.

A radio gramophone (Model ARG37) incorporating an automatic record changer has been introduced by E. K. Cole, Southend-on-Sea. The receiver incorporates variable selectivity, and bandspread tuning on seven short-wave bands. In addition to normal tuning on medium and long waves, there is provision for push-button selection of five pre-tuned stations, three on medium and two on long waves. The push-pull output stage delivers 8 watts to a 12-inch Goodmans loudspeaker with a frequency range of 30-10,000 c/s. A four-position tone control varies the balance from "bass boost with maximum top" to "normal bass and top cut." The pickup is a Garrard high-fidelity type with permanent sapphire stylus. Housed in a walnut veneer cabinet with anodised aluminium loudspeaker grille, the ARG37 costs £126 plus £27 1s 10d purchase tax.

The new Ekco universal receiver Model V49 is an A.C./D.C. version of the Model A23 with manual tuning on three wavebands and push button tuning for five stations. The short waves include the television sound channel. A four-valve plus rectifier superhet circuit is employed and the price is £23 2s plus £4 19s 4d purchase tax.

New Domestic Receivers

THE Model A746ARG radio-gramophone recently introduced by Philco Radio, Perivale, Greenford, is a six-valve (plus rectifier) superhet, covering long, medium and short waves, the latter from 10 to 66 metres in two ranges. There is an R.F. amplifier before the frequency changer and the output valve is a 6V6G. The record changer has a capacity of eight mixed 10- or 12-inch records and employs a moving-iron armature type of pick-up. The price of the A746ARG, which is housed in a figured walnut cabinet of dimensions 36½in × 32½in × 18in, is £78 15s, plus £17 1s 3d purchase tax.

Ultra Electric, Western Avenue, London, W.3, have produced an interesting A.C./D.C. superhet with a power output of 6 watts. This is obtained from two Mazda 10P14 tetrodes in push-pull. A choice of three combinations of wavebands is available; all three include the 200-550 metre band and the choice-of

the remaining pair lies between the following: 16-50m, 1,000-2,000m; 16-50m, 50-120m; or 11-22.5m, 23-51m. The price of the U51 is £25 plus £5 7s 6d purchase tax.

A seven-valve version of the post-war R.G.D. radio-gramophone has been developed and will be known as the Model 746G. It dispenses with an R.F. stage before the frequency changer and has a single pentode with feedback in the output stage. The pickup is designed to take standard steel needles. In general appearance and in the layout of the chassis it resembles

Ultra Model 51 which employs the Mazda low-consumption universal valves.



BELLING-LEE QUIZ (No. 15)

Answers to questions we are often asked by letter and telephone

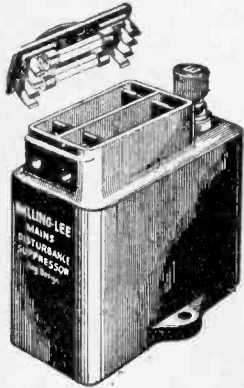

Question 44. *My broadcast programmes are being ruined by sizzles and crackles, plops and bangs. I have been told you can do something about it, what do you advise?*

Answer 44. This is typical of a number of enquiries we are getting daily and they are increasing. The noises typified by the descriptions given are caused by electrical machinery, instruments or appliances such as lifts, refrigerators, vacuum cleaners, hair driers, food mixers, bacon cutters, electro-medical appliances, etc., also electric signs and even household switches. Most things depending upon electric motors and most switches must be suspected. The interference they create is fed back on to the electric wiring and may either be conducted into your receiver, or may be re-radiated from the electric wiring on to your aerial.

The logical place to suppress the interference is at its source but there is, so far, no legislation to enforce this so we can only depend upon the goodwill of tradesmen who are generally reluctant to offend customers, and to ordinary neighbourliness.

If in real difficulty we suggest you go to the nearest post office and ask for the appropriate form which, when completed, will in due course bring a specially trained post office engineer who will investigate your problem and who will try to trace the source to the "butcher or baker or candlestick-maker," or to your downstairs neighbour who uses a vibro-massage equipment. It may

be your own refrigerator, in which case it is probably being troublesome to your near—and not so near—neighbours.

The post office engineer will probably recommend to the offender that a condenser suppressor *3 L.1118 be fitted at the troublesome appliance. If the source cannot be found then you may try the same suppressor fitted to your incoming mains.

The official view of the matter is that every listener should be able to enjoy reasonably interference-free reception from a choice of two B.B.C. programmes, using an aerial as good as the listener can be expected to erect, and that does not mean no aerial at all, or a wire round the room or under the carpet. Such an aerial picks up the programme and the interference from the electric wiring in the house: not a very happy state-of-affairs.

In very bad situations, or where a really critical listener is anxious either to listen to programmes from home or distant stations, it may be necessary to install a *1 "Skyrod" anti-interference aerial with *2 "Eliminoise" transformers. In not so bad cases a *4 "Winrod" window mounting aerial will suffice. It may be necessary to fit a set lead filter *5 L.300 close to the set as well as the special aerial, to keep interference from entering the receiver via the mains.

*1 "Skyrod" Reg. Trade Mark.

*2 "Eliminoise" anti-interference transformers Reg. Trade Mark. U.K. patents 477218, 479118.

*3 L.1118 Condenser suppressor. List price (as illustrated) 27/6.

*4 "Winrod" Reg. Trade Mark. List price 19/6.

*5 L.300/3 Set lead suppressor. List price 58/6.

B8A type VALVEHOLDER L620

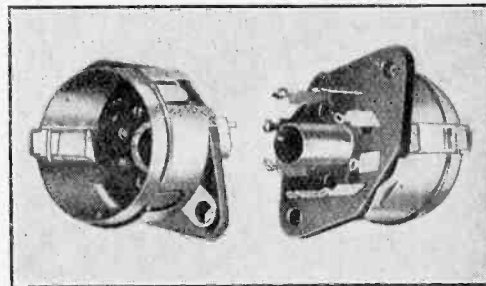

THE floating contact pen nib type sockets are constructed from a carefully controlled grade of silver-plated phosphor bronze and are designed to grip the valve pins with negligible transverse pressure. A neat spring circlip over the shroud ensures a snap lock-in. Insertion and withdrawal forces adjusted to secure adequately low contact resistance with minimum danger of damage to the valve.

The contact shape and size provide a low shunt capacitance, and will also handle a peak to peak voltage swing of 1,500 volts between every pair of adjacent contacts, or, between any contact and the spigot and shell connected together.

This test can be survived after a sample has been conditioned for 8 hrs at 60° C followed by 6 hrs at 60° C and 99% relative humidity, followed by a 1 hr drying period at 20° C and 60% R/H.

The holder complies with tentative specification agreed by the R.C.M.F. standardisation panel working in close collaboration with the radio and electronic engineering industry.

List No. L620. Price 9d. each.

BELLING & LEE LTD
CAMBRIDGE ARTERIAL ROAD, ENFIELD, MIDD'X

LONDON CENTRAL RADIO STORES

Special Offer of Ex. Govt.
Receivers, etc.

PARMEKO TRANSFORMERS

Type R1155 10-VALVE COMMUNICATION RECEIVER

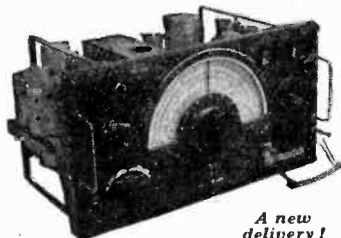

A new delivery!

These sets are equal to new, need only a power pack for immediate use (see "W.W.", July, 1946). Freq. range, 7.5 mc/s. or 1,500 kos. complete with 10 valves, including magic eye. Enclosed in strong metal **£15.00** box. Each receiver is aerial tested.
Carriage and packing 7/6 extra. No C.O.D.
POWER PACK 220-250 v. A.C. for above is available to CALLERS ONLY.

Type R1147B 7-VALVE U.H.F. RECEIVER Range approx. 200 megacycles

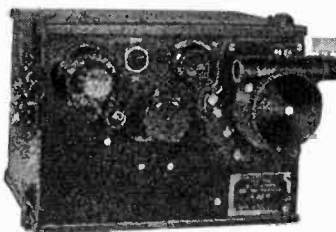

A Real Opportunity!

Beautifully constructed and fitted with micro-condenser drive. Valve type two EF50, two EF36, one each EBC33, RL7, RL16. In black metal case **£2.76** 8 x 7 x 6 in. Set, complete with valves . . .

TELEPHONE LINE or UNISELECTOR SWITCHES

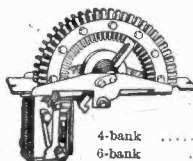

4- or 6-bank, 26 constants. Have various applications including automatic tuning, circuit selection, etc. Operates on 25-50v.

4-bank 28/6
6-bank 30/-

EX-GOVT. TELEPHONE HANDSETS

Self-Energising. Needs no battery or current. Less Wall bracket. Each **15/-**

ELECTRO MAGNETIC COUNTERS

Ex-G.P.O., every one perfect, electro-magnetic, 500 ohm, coil, counting to 9,999, operated from 25v.-50v. D.C., many industrial and domestic applications **5/6**

NO LISTS ISSUED

AIRBORNE G.P. TRANSMITTERS Type 1154

A few only to clear.

Complete with 4 valves. Frequency coverage: 500 kc/s, 200 kc/s, 10 mc/s, 3 mc/s, 2.35 mc/s, 8 mc/s, 2.8 mc/s. Power input 1,200 v., 200 ma., H.T. 6 v. 4 amp. L.T. Chassis size, 15in. x 13 1/2in. x 9in. In metal cabinet. Supplied in strong wood case, with metal bound corners and carrying handles, easily adapted for Amateur use. Less Power **£5.17.6**
Pack
Carriage and Packing 10/- extra.

RADAR VIEWING UNITS

Consisting of 6in. diameter Electrostatic O.R. tube, 7 valves including four EF50, potentiometers, resistances and other associated components. In metal cabinet 18 x 8 x 7 1/2in. Bargain price .. **£3.7.6**

A.C. MOTORS

220-240 v. 50~

Overall dim. 10" x 4"
1" Spindle both ends

37/6

Car. and pkg. 2/6 extra.

6-VALVE SHORT-WAVE RECEIVER Type R208

Precision-built Communication Type, Range 10-60 megacycles. Suitable for AC 100-250 v. or 6 v. battery operation. Metal rectifiers, B.F.O., Built-in Speaker, Super Slow motion dial. Provision for phones, etc. A real super job in grey metal cabinet. Complete with Valves and Vibrator ready to use **£18.0.0**
Carriage and packing 12/6 extra.

AMERICAN Aircraft RADAR UNIT Model "AN/APA-1"

Brand new. Complete as shown incorporating Power Pack, Cathode Ray Tube, etc. Book with Instructions with each unit. Carriage paid. **£5.10.6**

Super Quality Heavy Duty TWIN-ELEMENT SLIDING RESISTANCES

5.4 ohm at 20 amp. 47/6
12 ohm at 10 amp. 39/6
70 ohm at 5 amp. 35/-
Single Element 14 ohm at 5 amp. 13/6



★ TELEPHONE - LEICESTER 32287

Closed Thursdays 1 p.m. Open all day Saturday.

23, LISLE ST. (GER.2969) LONDON, W.C.2

WORLD OF WIRELESS

Scope of Radiolympia ♦ Record Exports ♦ London's Tele-cinemas ♦ French Television Standards

RADIOLYMPIA

THE number of exhibitors at the fifteenth National Radio Exhibition, which opens at Olympia on October 1st, has increased to 186.

The coverage of this, the first post-war Radiolympia, has been extended in scope to include, in addition to broadcasting and television equipment, navigational aids and the application of electronics to industrial processes.

Among the "non-commercial" users of radio who will be exhibiting is the Metropolitan Police Force which will be staging a demonstration of the V.H.F. system employed for communication between patrol cars and Scotland Yard.

A private view of the exhibition will be held on September 30th. The show will be open daily, except Sunday, between 11 a.m. and 10 p.m. from October 1st to 11th. Admission will be 2s 6d.

The next issue of *Wireless World* will be enlarged to include a comprehensive illustrated report of the show.

IMPORTS AND EXPORTS

FIGURES recently published by the Board of Trade show that the value of the exports of domestic receivers (including chassis substantially assembled) for the first half of the year was over ten times that of the corresponding period in 1938. In terms of quantity the 1947 figure is just under five times that of 1938.

In addition to the figures for domestic sets tabulated below, £625,128 worth of telecommunica-

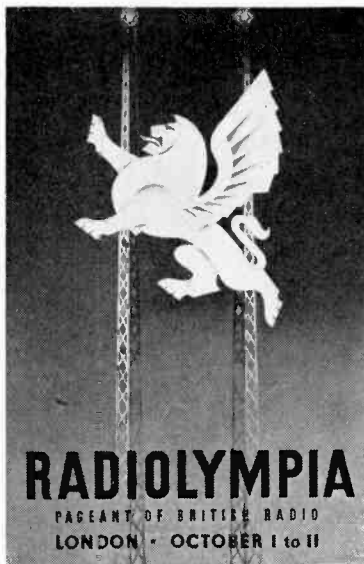

SYMBOLIC This poster and another giving fuller details is being used to advertise the exhibition.

tion equipment (excluding valves) was exported.

There has also been a considerable increase in the number of valves and cathode-ray tubes exported. During the period under review over 2,035,000 valves and C.R.T.s were exported compared with 1,103,000 during the same period in 1938. The respective values were £696,368 and £247,633.

When comparing the figures in

the table cognizance must be taken of the effect of the fuel shortage on production early in the year.

On the import side the value of domestic receivers brought into the country during the period January to June was less than 40% of the 1938 figure. In 1938 it was £60,886; 1946, £55,260; and 1947, £23,448. Whilst the value of imported valves had increased from £65,356 (1938) to £123,332 (1947) the number had decreased from 609,147 (1938) to 490,907 (1947). It should be pointed out that the 1947 figures include cathode-ray tubes.

CINEMA TELEVISION

NO technical details are at present available of the equipment to be used by the J. Arthur Rank Organization or large-screen television which, it has been announced, will be introduced in several London cinemas later this year.

Six cinemas will at first be equipped to receive transmissions from the Organization's research station at Sydenham, South London, which will be beamed to the West End for reception and redistribution.

FRENCH TELEVISION

A DECREE has recently been published by the French Government embodying the recommendations of the Joint Television Committee regarding the future of television in France.

The present standard of transmission from the Paris station (425 lines, 25 frames interlaced) will be continued for a period of ten years. A higher definition system (probably 1,029 lines) will also be put into service in the Capital within the next two or three years and extensions to the provinces will be on this standard.

Transmissions from Paris are at present radiated five days a week on 46 Mc/s (vision) and 42 Mc/s (sound).

MAGNETIC TAPE RECORDING

A MEETING was held recently at Broadcasting House to explore the possibility of standardization of magnetic tape and equipment for high-fidelity sound recording. Useful progress was made in fixing tape and spool sizes but it was thought that it was premature to attempt to

DOMESTIC RECEIVER EXPORTS (JAN.-JUNE)

To	Quantity			Value (£)		
	1938	1946	1947	1938	1946	1947
Channel Islands ...	1,644	6,100	2,541	9,580	53,750	30,719
Palestine ...	78	16,143	15,573	1,818	139,229	171,350
South Africa ...	2,223	8,418	20,789	16,188	71,374	230,305
India ...	2,453	24,836	52,292	16,854	207,098	546,096
Malaya ...	879	1,158	10,280	7,954	10,796	115,362
Other British Countries...	18,334	15,727	23,220	92,902	152,390	278,121
Belgium ...	154	7,635	8,444	1,038	65,521	72,073
Egypt ...	232	6,549	9,417	2,122	58,251	107,398
Persia ...	22	2,816	18,125	184	28,732	197,959
Brazil ...	445	509	7,756	1,789	4,830	94,138
Other Foreign Countries	15,856	16,180	38,096	70,103	148,353	401,990
Total	42,320	106,071	206,533	220,532	940,324	2,245,511

World of Wireless—

standardize magnetic characteristics.

When more data has been accumulated, it is proposed to hand over the results to the British Standards Institution as a basis for a standard specification. The meeting was attended by representatives of the B.B.C., B.I. Callender's Cables, Boosey & Hawkes, B.T.-H., E.M.I., G.E.C., Plessey, R.G.D., and Standard Telephones & Cables.

CAR RADIO TAX

AS foreshadowed in last month's issue, the Treasury has made an order, entitled "The Purchase Tax (Charges) (No. 2) Order, 1947," making receivers "designed for use on road vehicles" and valves for use in them chargeable with Purchase Tax at the basic rate of 33½% of the wholesale value.

The order came into force on August 11th.

RADIO RESEARCH

SOME months ago the Research Committee of the Institution of Electrical Engineers set up a panel to review the facilities for, and co-ordination of, radio research in Great Britain. The report of this panel has now been issued by the Institution.

Among the recommendations are the setting up of an agency, perhaps under the aegis of the Department of Scientific & Industrial Research, to disseminate details of research work; to continue the work undertaken during the war by the Radio Components Research and Development Committee of the Ministry of Supply by a Committee sponsored, say, by the Radio Industry Council and the Telecommunication Engineering and Manufacturing Association; and the provision of additional post-graduate scholarships in radio.

The report "British Research in the Radio Field" is obtainable from the I.E.E., price 1s.

I.E.E. PREMIUMS

A LARGE proportion of the awards by the Council of the Institution of Electrical Engineers of Premiums for papers read before the Institution or accepted for publication during the 1946-47 session deal with radio and allied subjects.

Among the awards were:—
Institution Premium (£50), Dr. H. G. Booker, "Slot Aerials and their Relation to Complementary Wire Aerials" and "The Elements of Wave Propagation using the Impedance Concept,"
Kelvin Premium (£25), Drs. H. A. H. Boot and J. T. Randall, "The Cavity Magnetron."

John Hopkinson Premium (£25), Dr. H. A. Thomas, "Industrial Applications of Electronic Techniques,"
Duddell Premium (£20), Dr. D. C. Epley, E. C. Cherry and M. Levy, "The Pulse-Testing of Wide-Band Networks,"
Ambrose Fleming Premium (£10), W. Ross, "Fundamental Problems in Radio Direc-

tion-Finding at High Frequencies (3.30 Mc/s)," "Site and Path Errors in Short-Wave Direction-Finding" and "The Development and Study of a Practical Spaced-Loop Radio Direction-Finder for High Frequencies."

£10 Premiums, C. Crampton, "Naval Radio Direction-Finding"; Dr. D. Gabor, "New Possibilities in Speech Transmission" and "Theory of Communication"; J. Bell, M. R. Gavin, Dr. E. G. James, and G. W. Warren, "Triodes for Very Short Waves."

£5 Premiums, C. J. Banwell, "The Use of a Common Aerial for Radar Transmission and Reception on 200 Mc/s," Dr. J. H. Fremlin, A. W. Gent, D. P. R. Petrie, P. J. Wallis and Dr. S. G. Tomlin, "Principles of Velocity Modulation," D. Cooke, Z. Jelonek, A. J. Oxford, and E. Fitch, "Pulse Communication."

PERSONALITIES

H. W. Allen is the sole survivor of the original staff of Marconi's Wireless Telegraph Co., formed on July 20th, 1897. He successively held the posts of secretary, general manager and deputy managing director. Other early members of the staff who are still living are: C. E. Rickard (1898), Andrew Gray, C. S. Franklin, H. M. Dowsett, P. J. Woodward and W. Densham (1899).

L. H. Bedford, O.B.E., M.A., B.Sc. (Eng.), Director of Research of Cossor's, is joining the English Electric Group of companies in October. It is understood that his work will be mainly with the Marconi Company at Chelmsford. He and Dr. J. M. Dodds



L. H. BEDFCRD, O.B.E.

(Metrovick) were the first industrial engineers to be taken into the confidence of the Government on radar. The "Bedford" attachment for early gun-laying radar was evolved by him. He is a vice-president of the Brit. I.R.E.

Leslie Gamage, joint managing director of G.E.C., has been re-elected chairman of the British Export Trade Research Organization (B.E.T.R.O.).

R. J. F. Howard, who was, until recently, in charge of the development laboratory of the industrial electronics section of English Electric, has joined British Electronic Products, Ltd., of Moxley Road, Bilston, Staffs, as chief engineer.

J. A. Roddy, who formerly handled television sales for Cossor, has been

transferred to Cossor Radar, Ltd., as contacts officer. He was a radio officer in the Merchant Navy from 1916 to 1928.

Dr. R. L. Smith-Rose, superintendent of the Radio Division, N.P.L., has been nominated vice-president of the American Institute of Radio Engineers for 1948.

C. E. Strong, O.B.E., B.A., B.A.I., the chairman of the I.E.E. Radio Section for the coming session, has been chief radio engineer of Standard Telephones and Cables since 1938, with which company and its associates he has served for 24 years. His work with the company has been largely concerned with the development of high-power transmitters. He is a member of the Technical Directive Board of the R.I.C. and recently visited India as a member of the R.I.C. delegation, which, at the invitation of the Government of India, was asked to advise on the technical problems of broadcasting in India.

Dr. Emrys Williams, B.Eng., Ph.D., who has been lecturer in electrical engineering at King's College, Newcastle-on-Tyne, for the past ten years, has been appointed Professor of Electrical Engineering, University of North Wales, Bangor. He was formerly in the G.E.C. Research Laboratories, Wembley. Dr. Williams was chairman of the I.E.E. North-Eastern Radio and Measurements Group for last session.

IN BRIEF

Television Tests using the method of transmitting sound and vision on one carrier, as in the Pye "Videoseonic System," have recently been made by the B.B.C. Reception on a receiver in which the scanning spot is not blacked out during the fly-back is, of course, marred by the sound signal which is inaudible.

International Stations.—Broadcasting authorities of twelve nations met in Paris at the beginning of August to discuss the creation of an international radio network. The proposal to establish an international network of stations to be operated by the United Nations Educational, Scientific and Cultural Organization (Unesco), was considered to be impracticable. The countries represented were Australia, Belgium, Brazil, Canada, China, Czechoslovakia, France, Mexico, Sweden, Switzerland, the U.K. and the U.S.A.

Electron-Microscopy.—The applications, rather than the construction, of the electron-microscope will be dealt with at the seventh conference on electron-microscopy which has been organized by the Electron-Microscopy Group of the Institute of Physics at the University of Leeds, on September 16th and 17th.

Canadian F.M.—Permission to erect frequency-modulation transmitters has been granted to nine commercial broadcasting stations in Canada and a further five applications are pending. None of the stations is at present operating.

Mexico has placed a temporary ban on the import of certain goods "considered as luxury or non-essential," among them are radio receivers.

Moroccan Experiment.—The chief engineer of the international broadcasting station in Tangier is interested in establishing 1-metre two-way working between Tangier and Gibraltar. Interested amateurs in Gibraltar should communicate with J. M. Cordova, Radio International, 34, Calle Goya, Tangier, Morocco.

B.I.F.—It is announced by the Board of Trade that the 1948 British Industries Fair will be held in London and Birmingham from May 3rd to 14th.

Colonial Radio-telephony.—Six British colonial territories were provided by Cable and Wireless and its associated companies with extended radio-telephone facilities during July: Kenya was linked with Australia, India, Barbados and Bermuda; Barbados and Bermuda with India, South Africa and Australia; Ceylon with South Africa and Australia; and Trinidad with Tobago.

International Amateur Radio.—Licensed amateurs from among the delegates of the seventy-five nations represented at the Atlantic City conference met informally at the invitation of local amateurs to discuss the importance of international amateur radio.

Chinese Amateurs are planning to hold an International Amateur Radio Exhibition in Chungking on May 5th next year.

Appointments Bureau.—The Professional Engineers' Appointments Bureau has been incorporated as a company under limited guarantee. Members of the Institutions of Electrical, Civil and Mechanical Engineers are invited to register and employers of professional engineers are invited to submit concise details of positions vacant on their staff to the Registrar, 13, Victoria Street, London, S.W.1.

A Scottish Branch of the Radar Association has now been formed. The secretary of the association, which aims at preserving "the comradeship founded in the (R.A.F.) radar commands regardless of trade or rank," is Alex Moore, 25, Wellington Street, Glasgow, C.1.

Speeding the Plough.—Transmitter-receivers are being produced in the U.S.S.R. for fitting to tractors in the main grain areas of Siberia and the North Caucasus to provide communication between the tractor stations and the agricultural centres. Next year 1,000 sets will be fitted and in 1949 the target is 3,000.

International Show.—An international radio exhibition is being planned jointly by the Czechoslovakian broadcasting authorities (Ceskoslovensky Rozhlas) and the International Broadcasting Organization. It will be held in Prague between May and September next year.

Marine Radar.—Twenty-five Swedish ships are to be fitted with 3.2-centimetre radar installations by the Radiomarine Corporation of America, a division of R.C.A.

Institute of Physics.—The annual report of the Institute records that its membership increased during the past year by 299 to 2,830.

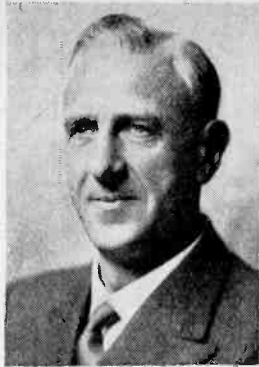

C. E. STRONG, O.B.E., the new chairman of the I.E.E. Radio Section.

I.E.E. Council.—The new president of the I.E.E., who will take office on September 30th, is P. Good, C.B.E., director of the British Standards Institution. Among the new members of the Council are two from the Radio Section: T. E. Goldup, a director of Mullards, and H. L. Kirke, C.B.E., head of the B.B.C. Research Department.

I.E.E. Radio Section.—The vacancies occurring on the Committee of the Radio Section of the I.E.E. on September 30th have now been filled. The new chairman is C. E. Strong, O.B.E., B.A.I (Standard Telecommunication Laboratories), and the vice-chairman, F. Smith, O.B.E. (M.O. Valve Co.). The ordinary members are: C. F. Booth (G.P.O. Research Station); H. W. Forshaw, O.B.E. (M.O.S. Directorate of Telecommunications Research and Development [Defence]); E. L. E. Pawley, M.Sc. (Eng.) (B.B.C.); and J. A. Ratcliffe, O.B.E., M.A. (Cavendish Laboratory, Cambridge).

B.S.R.A.—The first lecture of the 1947-48 season will be given by Dr. L. E. C. Hughes on the subject of "Sound and Its Relation to Recording" at the Royal Society of Arts, John Adam Street, London, W.C.2, on September 26th at 7 o.

Not Our Kind of Radio!—A prize of £20 is to be awarded by the British Society of Dowsers to the author of an article which, in the opinion of the Council, does most to promote the science or practice of dowsing or radiesthesia. The prizewinning article will be published in the Society's journal, *Radio-perception*.

Navigation Prize.—The council of the Royal Society of Arts is again offering a prize of £50 under the Thomas Gray Memorial Trust for an invention originated between January 1st, 1942, and December 31st, 1947, which, in the opinion of the judges, is considered to be an advancement in the science or practice of navigation. Entries, giving full particulars, should be sent to the Secretary, Royal Society of Arts, John Adam Street, Adelphi, London, W.C.2, between October 1st and December 31st.

Licences.—The June total of 10,861,650 broadcast receiving licences in Great Britain and Northern Ireland included 20,300 for television receivers. The month's increases were 79,650 and 1,450 respectively.

An Appeal.—A copy of the American journal *Electronics* for June, 1944, is required to complete a volume in a reference library. Will any reader who is willing to supply the missing number please send it to the Editor?

INDUSTRIAL NEWS

Pye.—In his report at the annual general meeting of Pye, the chairman, C. O. Stanley, stated that during the past year the company had made only one-third of the intended number of television sets. Cathode-ray tubes have been the controlling factor. In view of the limited output the price of Pye television sets has been increased to £42.

Bush.—The foundation stone of a new Bush Radio factory at Ernsettle, Plymouth, was recently laid by the Lord Mayor.

Philips Electrical.—From September 1st Philips Lamps, Ltd., will be known as Philips Electrical, Ltd., to be more in keeping with the wide range of Philips products.

Cossor radar scanner is being fitted on the roof of Olympia for the Engineering and Marine Exhibition which opens on August 28th. The scanner will feed a Cossor P.P.I. fitted in a replica of a ship's chart room.

New Zealand Importers.—Speddings, Ltd., of Commerce Building, Beach Road, Auckland, C.1, New Zealand, is celebrating its jubilee this year. The firm was among the first to import broadcast receivers into the Dominion, and hopes, when the present regulations are relaxed, to resume this activity. Speddings wish to hear from manufacturers who are considering extension of their export activities to New Zealand.

Half-thou. Foil.—Ratcliff Metals, of 21, New Summer Street, Birmingham, 19, are producing copper foil of the exceptional thinness of 0.0005in. The firm would be interested to hear from any wireless manufacturing firm having an application for this material.

Airmec Laboratories, Ltd., is the new name adopted by P.R.T. Laboratories. The address, Cressex, High Wycombe, Bucks, and telephone number, High Wycombe 2060-4, remain unchanged.

Marine P.A.—Ardente "Sonmarine" sound-reproducing equipment has been installed in the Southern Railway Company's S.S. "Dinard" and "Falaise." Separate circuits are used for general announcements and for musical programmes, and announcements are always made at full volume irrespective of the setting of the volume controls which are provided at most loudspeaker stations.

Ardente.—The temporary sales office of Ardente Acoustic Laboratories, Ltd., at 309, Oxford Street, London, W.1, has been closed and the sales department accommodated at the works at

World of Wireless—

"Limnerslease," Compton, near Guildford, Surrey. Tel.: Guildford 3278-9.

R.G.D.—The telephone number of the temporary London service depot of R.G.D. has been changed to Macaulay 5592.

Philco.—The address of the Sales Department of the Philco Radio and Television Corporation is now 204-206, Great Portland Street, London, W.1. Tel.: Euston 5566.

Frank Murphy of London, Ltd., has gone into liquidation as a result of a meeting of creditors on July 11th, when it was stated that there was a deficiency of £55,285. The company, incorporated in May, 1944, as a private company, was converted to a public company in June last year, and had premises in Liverpool, Hitchin and Nottingham. The liquidator is L. S. Findlay, 4, Charterhouse Square, London, E.C.1.

CLUBS

Bromley.—Meetings of the North-West Kent Amateur Radio Society will in future be held on the first Friday of each month at 8.0 at Aylesbury Road School, Bromley. The annual general meeting will be held in October. Sec.: L. Gregory, G2AVI, 18, Upper Park Road, Bromley, Kent.

Carlisle.—Meetings of the Carlisle Amateur Radio Society are held on the first and third Fridays of each month at 7.0 at the Richmond Hall, Y.M.C.A., Fisher Street, Carlisle. Sec.: J. Ostle, 2, Outgang, Aspatria, Carlisle, Cumbd.

Catterick.—New headquarters for the Catterick Amateur Radio Club have been established at Marne Lines, Catterick Camp, where the club transmitter has been installed (temporary call G3AKF/A). Meetings, Tuesdays 7.15. Sec.: Cpl. A. Hall, c/o 2 Sqn., 1st T.R., Royal Signals, Catterick Camp, Yorks.

Edgware.—A 1.8 Mc/s D.F. contest has been arranged by the Edgware and District Radio Society for Sunday, September 14th, which is open to non-members on payment of the entrance fee of 1s. Assembly point will be Stanmore (Bakerloo) station at 1.0. Intending contestants should notify H. W. Pope, G3HT, 4, Gainsborough Gardens, Edgware, not later than September 5th. Sec.: R. H. Newland, G3VW, 3, Albany Court, Montrose Avenue, Edgware, Middx.

Grimsby.—Transmitting members of the Grimsby Amateur Radio Society have been given QSL cards by the Grimsby Fish Merchants' and Fish Curers' Association. Visits by short-wave listeners to members' transmitters will be arranged by the Secretary, R. F. Borrill, G3TZ, 115, Garden Street, Grimsby, Lincs.

Harrogate.—Naval airborne radar gear will be described to members of the Harrogate and District Short-Wave Radio Society on September 3rd. Meetings are held on alternate Wednesdays at 7.30 at the Y.M.C.A., Victoria Avenue, Harrogate. Sec.: K. B. Moore, 2a, Wayside Crescent, Harrogate, Yorks.

Who Invented the Aerial— Marconi or Popov?

IN the Editorial of our May issue, writing on the subject of the Marconi Jubilee, we said that Marconi's first great technical contribution to the radio art was the addition of an elevated aerial to Hertz' oscillator. Some doubts have been expressed as to the correctness of this statement, and without taking sides on the issue, it seems appropriate to quote from an article by Marquis Luigi Solari in the April-May number of our Italian contemporary *L'Antenna*. Solari was a close friend and business associate of Marconi for many years. The following passages are translated directly from his article:—

The aerial was used by Marconi for the first time at the radio transmitting and receiving station of Pontecchio (Bologna) in 1896 and formed the principal and most ingenious part of the first Marconi patent dated 2nd June, 1897. There was much discussion about this because Prof. Popov, physics professor at the Imperial Naval College, Cronstadt had used in 1895 (one year before Marconi) an aerial, that is to say a wire supported by a tall wooden pole and with its lower end connected underneath to an apparatus for recording the electrical discharges of the atmosphere. This apparatus resembled as regards certain parts (I repeat: certain parts) the first Marconi receiving apparatus, but was merely used for recording the electrical discharges of the atmosphere. The Marconi receiver was very different, being far more complete and perfected, and was connected to a Morse instrument for receiving telegraph signals. However, the principal and decisive argument in favour of Marconi resides in the fact that Popov never used the aerial for transmitting electric waves and did not erect any installation for transmitting and receiving electric waves prior to Marconi. This was stated in my presence by Popov himself at Cronstadt in August, 1902, in the following circumstances:

At that time Marconi and I were on board the cruiser *Carlo Alberto* which had proceeded to Cronstadt on the occasion of the visit paid by the King of Italy to the Czar of Russia. The whole of the Russian Press then published enthusiastic articles on the wireless communication established by Marconi for the first time between Russia and Britain (the *Carlo Alberto*, in Russian waters, and Poldhu, Britain).

In view of this great event, Prof. Popov came on board the *Carlo Alberto* to pay tribute to Marconi.

Marconi and I were close to the gangway of the *Carlo Alberto* to receive Prof. Popov, who, as he stepped on board, expressed himself in these exact words: "I should like to greet the father of wireless telegraphy." Marconi shook him very warmly by the hand, took him down to the admiral's cabin and asked him about his experiments. Popov (who was then about fifty years of age) mentioned that he had conducted some experiments in 1895 for recording electrical discharges in the atmosphere, but stated most definitely that he had never effected any transmission of electric waves before Marconi, or any wireless telegraphy communication, and that his research had been confined to electrical discharges in the atmosphere.

Discussion on the aerial used in wireless may thus be considered closed, but before leaving this subject, I should like to repeat exactly the statements made on this matter by Prof. Righi, the well-known continuator of Hertz' experiments and Prof. Slaby, who founded the first German wireless company "Telefunken," after visiting the first Marconi station in Great Britain.

Marquis Solari ends his article by quoting verbatim statements by Righi and Slaby in support of Marconi's priority in the use of an elevated aerial, and stresses the importance of this addition to the equipment of earlier workers.

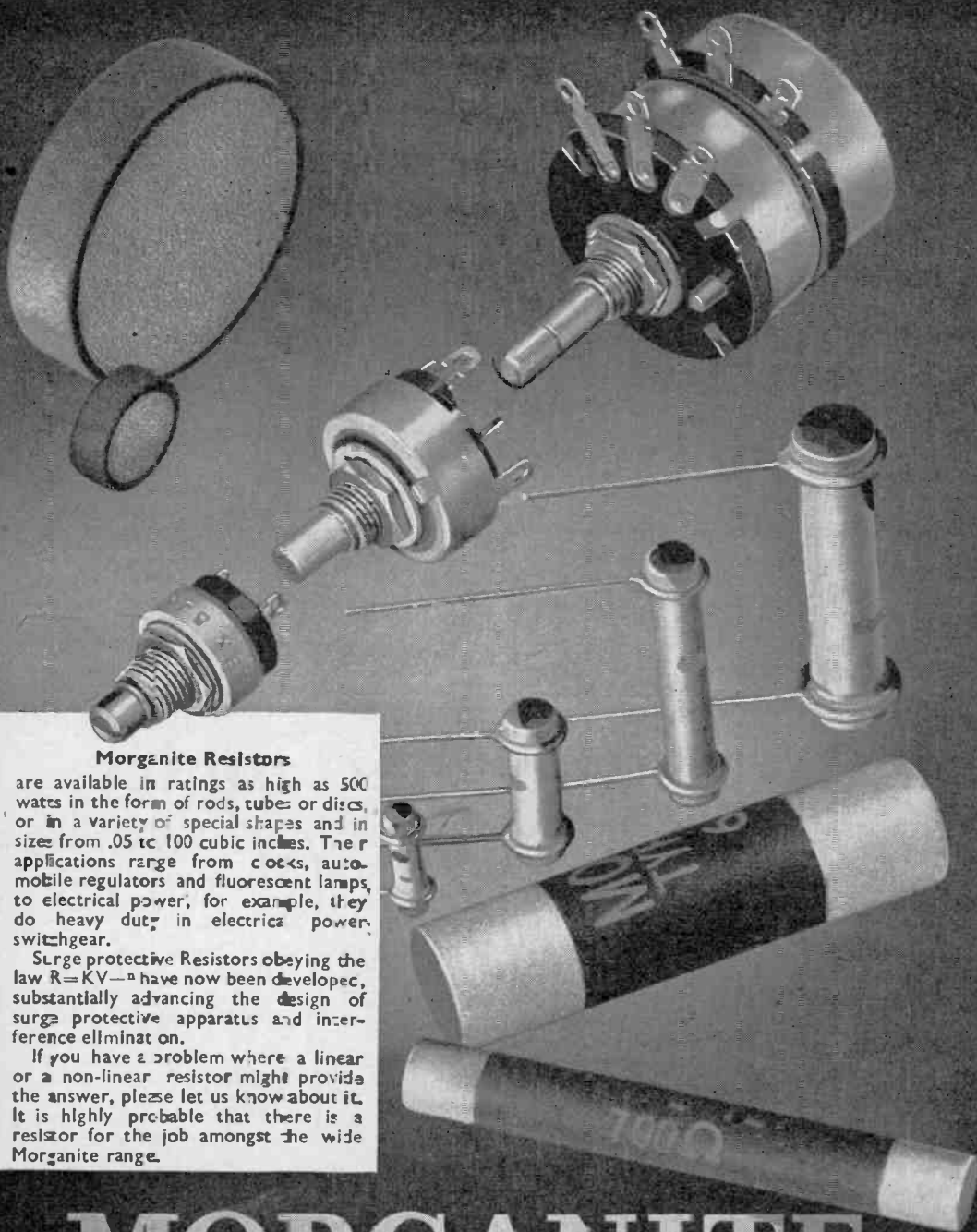

Morganite Resistors

are available in ratings as high as 500 watts in the form of rods, tubes or discs, or in a variety of special shapes and in sizes from .05 to 100 cubic inches. Their applications range from cocks, automobile regulators and fluorescent lamps, to electrical power; for example, they do heavy duty in electrical power switchgear.

Surge protective Resistors obeying the law $R=KV^{-2}$ have now been developed, substantially advancing the design of surge protective apparatus and interference elimination.

If you have a problem where a linear or a non-linear resistor might provide the answer, please let us know about it. It is highly probable that there is a resistor for the job amongst the wide Morganite range.

MORGANITE

THE MORGAN CRUCIBLE COMPANY, LIMITED, LONDON, S.W.11

Delivering the goods during RADIOLYMPIA



It is our experience that Radiolympia does not provide ideal aural conditions; you can look but you cannot usually listen to the best advantage. Therefore, we respectfully suggest you look by all means at anything and everything, but listen to really amazing reproduction, at a reasonable price, at your nearest Sound Sales agent; alternatively, you will be more than welcome at our London office and showrooms. In the meantime, the enormous order book from Home and Overseas necessitates every available moment being devoted to production.

AUTOMATIC CHANGER POLYPHONIC RADIOGRAM
£82 10s. 0d., plus Purchase Tax.

NON-AUTOMATIC POLYPHONIC RADIOGRAM
£67 10s. 0d., plus Purchase Tax

PHASE INVERTER SPEAKER £12 10s. 0d.

Sound Sales Ltd.

57, St. Martin's Lane, W.C.2. (Temple Bar 4284)

Works: Farnham, Surrey. (Farnham 6461/2/3).

AGENTS. Barnes & Avis, Reading; Bowers & Wilkins, Worthing; Binns Ltd., Newcastle; Dalton & Sons Ltd., Derby; Clark & Sons, Isle of Wight; C. C. Gerry, Newquay; Hickie & Hickie Ltd., Reading (and branches); Thomas Lynn & Sons, Andover; Merriotts Ltd., Bristol; Needham Engineering Ltd., Sheffield; Pank's Radio, Norwich; Sound Ltd., Cardiff; Bernhard Smith, Barnstaple; Sound Services, Jersey, C.I.; Precision Services, Edinburgh; Seals Ltd., Southsea; G. E. Samways, Hazel Grove; Weybridge Radio Electric, Weybridge; West End Radio, Farnham; Vallance & Davidson Ltd., Leeds (and Branches).

Careers in Electronics

There is vast scope for ambitious men and women in the new fields opened up by Electronic Science. The Correspondence and College Courses provided by E.M.I. Institutes which cover recognised diplomas such as the City and Guilds, etc. are written and supervised by E.M.I.★ scientists who are specialists in Electronic Science. Here are some of the careers for which you can be trained:

**SERVICE
ENGINEERING
•
OPERATING
•
DESIGN AND
DEVELOPMENT
•
TECHNICAL
SALESMANSHIP
•
TEACHING**

TELEVISION and RADIO.
COMMUNICATION ENGINEERING—Land, Sea and Air.
RADAR.
NAVIGATIONAL AIDS.
INDUSTRIAL ELECTRONIC APPLICATIONS.
MEDICAL EQUIPMENT.
AUDIO-FREQUENCY, INCLUDING FILMS, etc.

Also short Courses for Executives, Amateurs, Schoolboys, etc.
For full details apply to your local "H.M.V." Radio dealer or direct to:—

Principal: PROFESSOR H. F. TREWMAN, M.A. (Cantab), M.I.E.E.,
M.I.Mech.E., M.Brit.I.R.E.



E.M.I. INSTITUTES LTD.

Dept.16, 43 GROVE PARK ROAD, CHISWICK, LONDON, W.4

★ The E.M.I. Group includes "H.M.V."; Marconiphone and other important electronic interests.

Magnetic Units

By "CATHODE RAY"

Guide Through the Mazes of the C.G.S. and M.K.S. Systems

A READER has suggested that it would be a good thing if I were to clarify magnetism. He says that most students get muddled with all the different units—lines, gauss, gilberts, webers, oersteds, and so forth—and their relationships to one another. I sympathize very warmly, because I have found them most remarkably muddling. The fact that the meanings of some of these units have been officially altered from time to time has not tended to make matters any easier.

Before discussing the units, it would be just as well to be quite clear about what they are units of. So let us recapitulate.

Most of the books base everything on "unit magnetic poles," although the more honest of them admit that no such things exist. Nor do lines of force, of course; but, like the lines that cartoonists draw to represent indignation radiating from Saturday's goal-keeper, they are a convenient means of visualizing something that does exist. Unit poles, on the other hand, are a purely hypothetical idea, corresponding to nothing that has ever been observed in nature. They are not even necessary to an understanding of the subject.

So we start off with that peculiar state of affairs found in the neighbourhood of electric currents—a magnetic field. Important effects produced by magnetic fields are the mechanical forces exerted on moving electric charges (i.e., electric currents), and the E.M.F.s generated by moving or varying magnetic fields. The name given to the magnetic quantity that determines the force or E.M.F. in a given region is flux (ϕ). The mechanical force is proportional to ϕ , and the E.M.F. proportional to rate of change of flux, $\frac{d\phi}{dt}$.

The influence that causes magnetic flux is named magnetomotive force (F), and is the thing that coils are designed to produce.

At this stage it is customary to bring in the electrical analogy,

saying that flux corresponds to current, and M.M.F. to E.M.F., and therefore the ratio $\frac{F}{\phi}$ corresponds to the ratio $\frac{E}{I}$, which everybody knows is resistance. $\frac{F}{\phi}$ is named, quite understandably reluctance; and is denoted, not so understandably, by S.

This analogy is a very useful one, but quite likely to lead to confusion unless two things are noted about it. The first is that the closest analogy is not between magnetic fields and electric current, but between magnetic field and electric field. It is a fundamental principle of teaching, however, that the obscure should not be explained in terms of the still more obscure. Magnetic fields are often tackled at a stage when the student is familiar with volts and amps, but is not at all clear about

electric field and displacement. So he is generally introduced at once to the electric circuit analogy, which may rather spoil him for the more perfect field analogy later. It is necessary to beware against tying oneself too tightly and permanently to the former, because magnetic flux and electric current are really quite different sort of things, and one should try to outgrow the need for having to bring in current in order to think about flux.

The other thing (as I explained in connection with permanent magnets) is that the most commonly used magnetic relationship is not between flux, M.M.F., and reluctance, but between flux density (B) (=flux per unit area), magnetizing force (H) (=M.M.F. per unit length), and permeability (μ). This corresponds to an electric current relationship that is comparatively seldom used, and therefore perhaps less helpful as an analogy, namely, that between current density, E.M.F. per unit length, and conductivity. If one takes the trouble to follow up this point, it is likely to be well worth it for the clearer understanding gained.

The reason for showing magnetic data as B/H or permeability curves, instead of F/ ϕ or reluctance curves, you remember, is that reluctance is a function of the size of the magnetic path as

TABLE 1

Magnetic Quantity	Symbol	Corresponding in electric circuit to—
(1) Flux	ϕ	Current
(2) Magnetomotive force	F	Electromotive force
The ratio of (2) to (1) is		
(3) Reluctance	S	Resistance
Sometimes it is more convenient to use the ratio of (1) to (2) —		
(3a) Permeance		Conductance
Getting down to unit dimensions, there follow —		
(4) Flux density	B	Current density
(ϕ per unit cross-section area)		
(5) Magnetizing force	H	Voltage gradient
(F per unit length of path)		
So in a magnetic circuit $F = Hl$		
And the ratio of (5) to (4) is —		
(6) Reluctivity		Resistivity
But usually the ratio of (4) to (5) is used: —		
(6a) Permeability	μ	Conductivity

Magnetic Units—

well as of the material occupying it. The information can be generalized for any material by dividing flux by unit area of the path's cross-section, and M.M.F. by its length, giving reluctance per unit cube, or reluctivity, which is $\frac{1}{\mu}$.

One other thing to recall is the magnetic equivalent of Kirchhoff's Second Law (about the sum of the potential drops in a circuit being equal and opposite to the sum of the E.M.F.'s). Both E.M.F. and potential difference are measured in volts, although one is cause and the other effect; like the mechanical back-pressure when you push against a wall. The idea of magnetic potential difference is worth grasping, because the total M.M.F. needed to produce a required flux in a magnetic circuit is equal to the sum of the magnetic potentials across all the parts of the circuit in series.

The chief magnetic quantities, then, with the corresponding quantities in the electric circuit are shown on the preceding page (Table 1).

Nos. (1) and (2) are cross-related with their corresponding electric circuit quantities; current produces M.M.F., and varying flux produces E.M.F. (In the true, or field, analogy, the quantity corresponding to magnetic flux is electric flux, emanating from a charge; M.M.F. is caused by varying electric flux).

The basic relationships of all these things are, of course, pre-set by Nature; but it is up to human wit to express them as simply as possible. Ohm's Law is a good model. But we find that with the units used in most books the E.M.F. generated by flux changing at unit rate is, not 1 volt, but 0.01 microvolt. And 1 ampere-turn gives rise, not to unit

M.M.F., but to $\frac{10}{4\pi}$ units. The

more theoretical aspects are worse still. Whereas unit electric charge is said to give rise to 1 line of electric flux, the corresponding unit magnetic pole is said to give rise to 4π lines of magnetic flux.

Any common-sense student approaching this subject with a fresh and open mind would say: "I know about volts, amps, ohms,

watts, etc., and I like them, because I don't have to bother about constants—in Ohm's Law, for example. Is there any reason why the magnetic units shouldn't follow on in the same scheme, so that constants only appear where there is a good and obvious reason?"

The answer is that the system of units officially and internationally approved as long ago as 1935 does fit the practical unit scheme. But the majority of people still cling to various pure and adulterated forms of several pre-1935 systems. Admittedly it is difficult to get a deeply established system changed, even for a better one; and in this particular situation there is a rather awkward complication. There are two different versions of the new system, and opinion on them was so divided that the international conference (as is the manner with international conferences) just couldn't decide either way, and hopefully left it to sort itself out.

C.G.S. System of Units

It is a long story, but briefly the sequence of events is this. The fundamental physical quantities are length, mass and time; and when units have been fixed for these, systems of units for other quantities can be based on them. For scientific purposes, the basis is generally the centimetre, gram, and second (c.g.s. system). One can start off deriving electrical units by defining unit charge as that which, placed 1 cm from equal charge of opposite sign, attracts it with a 1 c.g.s. unit of force (dyne); and from that build up a consistent system of electrical units. More than that; as magnetic quantities are inter-related, magnetic units can be derived as part of the same system.

But if one starts off on the other foot, by considering the force (also in dynes) between the imaginary unit magnetic poles (also 1 cm apart), another c.g.s. system of electric and magnetic units can be built up. Unfortunately the two systems disagree by the considerable factor of approximately 30,000,000,000, which turns out to be the speed of light through space, in c.g.s. units. This is not just a coincidence, of course, because light consists of electromagnetic waves, and its

velocity is a result of interrelated electric and magnetic forces. Calculation of these forces brings in two characteristics of space (or whatever else the waves are travelling in); on the magnetic side is permeability (μ), and on the electric side permittivity (κ). It works out that the velocity of electromagnetic waves in space,

denoted by c , is equal to $\frac{1}{\sqrt{\mu_0 \kappa_0}}$.

μ_0 and κ_0 being the μ and κ for empty space. Now we know c by experiment, so we know $\mu_0 \times \kappa_0$, but neither μ_0 nor κ_0 separately. If μ_0 is assumed to be 1, it follows that all the electric and magnetic units are precisely those arrived at by considering the forces between magnetic poles, i.e., the electromagnetic c.g.s. system. κ_0 is then found to be $1/c^2$, or approximately

$1/900,000,000,000,000,000,000$, which is not a particularly convenient number. On the other hand, if for simplicity κ_0 is taken as 1, resulting in the electrostatic c.g.s. system of units, μ_0 must be $1/900 \dots \dots$ —well, $1/9 \times 10^{20}$).

So whatever is done, κ_0 and μ_0 cannot both be 1 at the same time, because that would mean altering the universe to make the velocity of light 1 cm per sec, which would be awkward.

In the meantime, neither of the c.g.s. systems had suited the electrical engineers of the time, because the units were nearly all much larger or smaller than the magnitudes they were used to. So they had created the so-called "practical" units, derived from the e.m.c.g.s. units by multiplying them by what were considered suitable powers of 10. This was how we got our volt, amp, ohm, henry, farad, etc. (By the way, directly a factor is applied to one of the c.g.s. units to make it a more handy size, the factors for the others follow automatically. So the farad couldn't be helped! It might have been worse; the other practical units are fairly reasonable). The magnetic units remained just as they were in the e.m.c.g.s. system, and involve factors like 10^8 when calculating the E.M.F. generated by varying magnetic flux. When working with basic electrostatic relationships, one has either to use the entirely different e.s.c.g.s. system

of units, or else stick to e.m.c.g.s. or practical units and have huge powers of 10 and 3 everywhere. And just to make it more difficult somebody had introduced 4π differently in electric and magnetic theory, thereby spoiling the analogy between them.

Is it surprising that the student is muddled? Especially when he is now faced with two varieties of still another system!

M.K.S. System of Units

By basing all units on the metre and kilogram instead of the centimetre and gramme, the three foregoing systems merge into one, which, fortunately, includes all the familiar volt-amp-ohm practical series. The unit of magnetic flux turns out to be 10^8 times as large as the e.m.c.g.s. unit, leading to the happy result that when it changes at the rate of 1 unit per second the E.M.F. generated in an interlinked path is 1 volt.

The fact that the dimensions are in metres is perhaps not quite in tune with the present trend towards miniaturization, and may be one reason why radio engineers haven't leapt to embrace the m.k.s. system, as it is called. Those who are concerned with aeriels, feeders, and propagation should be quite happy with it, however.

The silly factor of 10 in the M.M.F. formula drops out, of course, but what about the 4π , also silly? It is because of it that some authorities (following Heaviside) go further and, as they say, *rationalize* the m.k.s. system. They simply alter the sizes of the unrationalized m.k.s. units of M.M.F., field strength, and reluctance to fit, and at the same time imagine unit magnetic pole to be the thing from which 1 line (not 4π lines) of magnetic flux originates, making it correspond with the 1 electric flux line from unit charge. All this leads to delightfully simple results; for example, the M.M.F. along any magnetic path surrounding a straight wire carrying a current of 1 amp is 1 rationalized m.k.s. unit. The same holds good inside a toroidal coil or a long solenoid or an iron-cored coil. At the same time the electric 4π 's are cleared up too. In the theory of electromagnetic waves it is even more helpful, and

most of us need all the help we can get in that subject.

Where is the catch?

We have seen that it is absolutely impossible for both μ_0 and κ_0 to be 1 in any single system of units. So one or both are bound to be more or less awkward constants. To fit the unrationalized m.k.s. system, μ_0 has to be $1/10^7$, and κ_0 , $1/(9 \times 10^9)$. To rationalize, these values are altered by the factor 4π ($\mu_0 = 4\pi/10^7$; $\kappa_0 = 1/(36\pi \times 10^9)$). Seeing that they cannot, in any case, both be ideally simple, one might as well hide *all* the awkward features away in them, for the sake of perfect tidiness everywhere else.

But, you may say, is it really tidy everywhere else? B in air used to be conveniently equal to H, and now we are asked to make it $4\pi H \times 10^{-7}$! Well, there is bound to be a ragged end somewhere, and if you can think of a better place to hide it, say on. It is easier, surely, to tie an inevitable odd number to one particular thing (and a rather mysterious indeterminate thing at that) than have it spread illogically all over the place in a way that just has to be memorized.

A New Start

As I said, there is a lot more in the story, which provides unlimited scope for argument; and I can quite understand anybody resenting the m.k.s. system as tending to make confusion worse confounded. (That was why I didn't dare to divide the issue by introducing it into "Permanent Magnets" last month, especially as magnet data are invariably in gauss and oersteds). If the c.g.s. systems could be blotted out from every textbook and every lecturer's mind and notes, and if the rationalized units were given names, I think there could be no doubt at all that the latter would be accepted universally. Anybody who has still to learn electromagnetics would find his brain run much cooler if he could work from the start in rationalized m.k.s. units. That, I think, is the justification for asking everybody to learn them now, in addition to any systems already held, for the sake of future generations of students. It is likely to pay some dividends even to us, by showing



20-25-WATT UNIVERSAL AMPLIFIER—U885

Gives considerably greater power output than usually expected from A.C./D.C. equipment. Constructed on the same lines as our 30-watt A.C. model and fitted with latest control panel carrying microphone, gramophone and tone controls, mains switch and pilot lamp and special 3-position switch providing either change-over or mixer circuit for gramophone and microphone. Three-stage high-gain type having four valves in parallel push-pull in output stage, a total of 10 valves. Output for high and low impedance speaker circuits.

Full details of this and other models sent on request.



TRIX

Quality
SOUND EQUIPMENT

THE TRIX ELECTRICAL CO. LTD.

1-3 MAPLE PLACE, TOTTENHAM COURT ROAD, LONDON, W. 3.
TELEPHONE: MUSEUM 5917 GRANS & CABLES: TRIXADIO, WESDO, LONDON.

Magnetic Units—

up basic theory in all its unobscured simplicity.

Here, for example, are a few of the relationships of rationalized m.k.s. units:—

Suppose a coil of N turns carrying a current of I amps has an iron core. A square metres in section and l metres long, which can be assumed to carry all the flux (see Fig. and Table 2). Then the M.M.F. is NI units, the magnetizing force is NI/l units, the flux density is $\mu NI/l$ webers per sq metre and the flux is $\mu NIA/l$ webers. So if the current varies at the rate of 1 amp per second, the flux varies at the rate of $\mu NIA/l$ webers per second, and the back-e.m.f. generated in each turn is $\mu NIA/l$ volts. The total back-e.m.f. is, therefore, $\mu N^2IA/l$ volts, and the self-inductance of the coil (by definition of the henry) is $\mu N^2IA/l$ henries. What could be easier?

Considering turns as simply a scheme for multiplying current, M.M.F. is seen to be measured in amps, just as E.M.F. is measured in volts. And just as conductance in an electric circuit is equal to conductivity multiplied by a size factor $\left(\frac{\text{area}}{\text{length}}\right)$, inductance (of one turn) is equal to permeability multiplied by $\frac{A}{l}$. (And, incidentally, capacitance is equal to κ multiplied by $\frac{A}{l}$, where A is the area of each plate and l the dis-

the corresponding capacitance is equal to κ). So it is reasonable to refer to the value of μ_0 in the rationalized m.k.s. system as

1.257 micro-henries per metre (and κ_0 as 8.854 picofarads per metre). Of course, plates or coils of these unit dimensions would have large "edge effects," so are to be regarded theoretically only; but if the constants μ_0 and κ_0 are remembered in the above form they can be used in practical problems. For example, the capacitance of a condenser with one dielectric 0.01 sq metre in area and 0.0004 metre thick, and with relative permittivity (or dielectric constant) 5, is $\frac{8.854 \times 0.01 \times 5}{0.0004} = 1107\text{pF}$. And

the inductance per turn of a toroidal air-cored coil 0.8 metre along the axis and 0.001 sq metre section is $\frac{1.257 \times 0.001}{0.8} = 0.00157 \mu\text{H}$. If the number of turns were 400, the inductance of the coil would be $0.00157 \times 400^2 = 251 \mu\text{H}$. One could go on to show how

ally from all this; and how it simplifies cathode-ray tube and waveguide theory. But perhaps enough has been said to convince

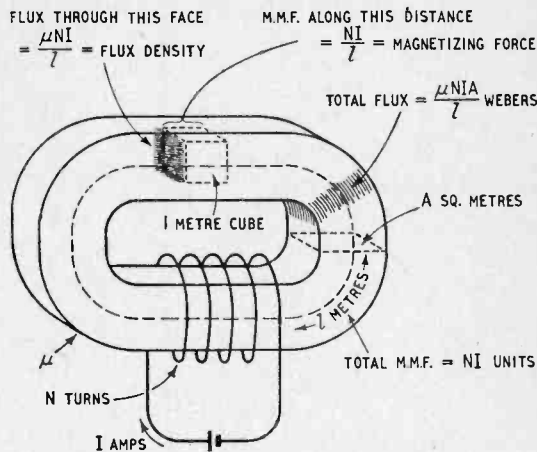

Showing the simple relationships between magnetic units in the rationalized m.k.s. system. The usual mixed "practical" and c.g.s. system necessitates various constant factors composed of 10 and 4π .

you that you should start your baby now on m.k.s. Refuse worthless substitutes; insist on genuine rationalized brand m.k.s.!

BOOKS RECEIVED

Calculating Machines, by D. R. Hartree, F.R.S., Plummer Professor of Mathematical Physics, Cambridge University.

Reprint of an inaugural lecture on recent and prospective developments in the design of calculating machines, and their impact on mathematical physics. Contains photographs and a description of the E.N.I.A.C. machine, but deals with its functions rather than its anatomy. Pp. 40; two plates. Published by the Cambridge University Press. Price 2s.

Drafting for Electronics.—By L. F. B. Carini, Ph.D. After dealing at some length with the fundamentals of instrument drawing the author devotes five chapters to Schematic Delineation, Schematic Circuit Projection, Schematic Patent Drawing, Industrial Electronics and Technical Outline Drawings. Other chapters deal with the preparation of graphs and of drawings for reproduction. The twenty-page appendix includes relevant data, conversion tables and a bibliography of visual aids. All material is based on standards of the American Standards Association and the American Institute of Radio Engineers. 217+ix pages with 186 figures. McGraw Hill Publishing Co., Ltd., Aldwych House, London, W.C.2. Price 12s 6d.

TABLE 2

Quantity	Symbol	Rationalized m.k.s. unit	Relationship to e.m.c.g.s. unit
Mass	m	kilogramme	= 10^3 grammes
Length	l	metre	= 10^2 cms
Mechanical force	F	newton	= 10^5 dynes
Magnetic flux	I	weber	= 10^8 maxwells (or lines)
Magnetic flux density	B	weber per sq metre	= 10^4 gauss (or lines per sq cm)
Magnetomotive force	F	ampere-turn	= $4\pi/10$ gilberts
Magnetizing force, or magnetic field strength	H	amp-turn er metre	= $4\pi/10^3$ oersteds
Absolute permeability	μ		= $4\pi/10^7 \times \mu_{(c.g.s.)}$
Relative permeability	$\frac{\mu_r}{(=\mu/\mu_0)}$		Same in both systems (= 1 for vacuum)

tance between). If A and l are 1 metre, the inductance of the arrangement is equal to μ (and

the speed of waves along transmission lines, and their characteristic impedance, follow natur-

LETTERS TO THE EDITOR

"Damping Factor" * Thunderstorms and Television Signals * Close-Spaced Television Aerials * What is a Filter?

Loudspeaker Damping

I WAS extremely interested to read the letter by F. Langford-Smith in your August issue on speaker damping.

I have thought for some time that, within limits, the output impedance of an amplifier is not so important as is often stated. If one considers a triode amplifier having a typical output impedance of, say, 3 ohms feeding a 15-ohm speaker having a D.C. resistance of, say, 10 ohms, the resistance of the circuit can only be reduced to 10 ohms compared with 13 ohms, even if the output impedance of the amplifier is zero. Unless negative feedback is applied from the secondary of the output transformer, the output impedance of the amplifier includes the resistance and leakage reactance of the transformer, which are by no means negligible in a normal transformer (say, 1 to 2 ohms).

Some time ago, with the help of a colleague, I performed some experiments on a cathode follower. A triode amplifier was constructed so that the output valve could be changed by means of a switch from normal operation to operation as a cathode follower. By measuring the output impedance on the secondary of the output transformer the value obtained as a cathode follower was about half that obtained with the amplifier operating in the normal manner. Aural tests were made with a number of observers. Most observers stated that they could not tell any difference, and those that said they thought they could were actually unable to tell, with any certainty, which arrangement was actually in use. Tests were also taken with an oscillograph by observing the damped oscillation obtained across the speech coil when the speaker was fed with sharp pulses. No conclusive difference could be observed.

Although these tests were never really completed, we came to the conclusion that if there was any difference in the performance it was so small as to be not worth while.

I think that many of the statements made about amplifiers having much better transient response due to lower output impedance are misleading. The conditions of tests are, I think, often doubtful. It is a fact that one imagines a new am-

plifier (particularly if you have just built it) to be better than the old one if you are unable to compare them side by side. The only real test is to have the two amplifiers arranged so that they can be switched quickly from one to the other. The actual amplifier used should not be known to the listener.

G. N. PATCHETT.

Eccleshill, Bradford.

F. LANGFORD SMITH has assumed a series resistance twenty times the resistance of an ideal loudspeaker on the basis of 5 per cent efficiency. Whilst this may be so when referred to middle frequencies, the efficiency is many times greater than 5 per cent at the resonant frequency, and it is at the resonant frequency that the damping factor becomes important.

If we assume an efficiency of 40 per cent at resonance, then with an ideal amplifier of zero output resistance the effective damping factor would be 0.66. We can therefore say that the amplifier damping factor must be large compared with this figure. For practical applications it would seem that increasing the amplifier damping factor above 4 or 5 will result in little or no audible improvement whatsoever, and this is certainly borne out by tests which the writer and his colleagues have been able to carry out.

P. J. WALKER.

The Acoustical Mfg. Co., Ltd.,
Huntingdon.

F. LANGFORD SMITH'S suggestion that the electromagnetic damping of a loudspeaker is limited by the equivalent series impedance (or resistance) of the loudspeaker itself is quite sound, and if the efficiency of the loudspeaker is 5 per cent, then the equivalent series resistance will be large enough to make the effects of a low output impedance negligible.

The point which is overlooked, however, is that at resonance points the efficiency rises to a value considerably higher than the mean efficiency. The result is that the equivalent resistance is reduced and the damping improved at these points where damping is needed.

C. J. MITCHELL.

Cuffley, Herts.

(Letters continue on page 344.)

Vortexion



C.P.20A 15 WATT AMPLIFIER

for 12 volt battery and A.C. Mains operation. This improved version has switch change-over from A.C. to D.C. and "stand by" positions and only consumes 5½ amperes from 12 volt battery. Fitted mu-metal shielded microphone transformer for 15 ohm microphone, and provision for crystal or moving iron pick-up with tone control for bass and top and outputs for 7.5 and 15 ohms. Complete in steel case with valves.

As illustrated. Price £28 0 0

"SUPER FIFTY WATT" AMPLIFIER

This Amplifier has a response of 30 cps. to 25,000 cps., within ½ db., under 2 per cent distortion at 40 watts and 1 per cent. at 15 watts, including noise and distortion of pre-amplifier and microphone transformer. Electronic mixing for microphone and gramophone of either high or low impedance with top and bass controls. Output for 15/250 ohms with generous voice coil feedback to minimise speaker distortion. New style easy access steel case gives recessed controls, making transport safe and easy. Exceedingly well ventilated for long life. Amplifier complete in steel case, with built-in 15 ohm mu-metal shielded microphone transformer, tropical finish.

Price 36½ Gns.

AD/47 10-VALVE TRIODE CATHODE FOLLOWER AMPLIFIER

For this recording and play-back Amplifier we claim an overall distortion of only 0.01% as measured on a distortion factor meter at middle frequencies for a 10-watt output. The output transformer can be switched from 15 ohms to 2,000 ohms, for recording purposes, the measured damping factor being 40 times in each case. Full details upon request.

Dealers and Export Agents should write for special terms to:—

VORTEXION LTD.

257-261, THE BROADWAY,
WIMBLEDON, LONDON, S.W.19

Telephones: LIBerty 2814 and 6242/3.

Telegrams: "VORTEXION, WIMBLE, LONDON."

Letters to the Editor—

WHEN thinking of damping we are more concerned with the loudspeaker as a current generator than with its efficiency as an electro-acoustic device. The damping depends on the current generated by the speech coil moving in a magnetic field, and this current is obviously dependent on the total effective impedance in the loudspeaker circuit.

If we take as example a 10-Ω speech coil in circuits having damping factors of 1 and 20, the corresponding total circuit impedances will be 20 Ω and 10.5 Ω respectively. The damping current is clearly greater in the second case, and this improvement stands, regardless of loudspeaker efficiency.

Nevertheless, Mr. Langford Smith is quite correct when he states that progressively increasing the damping factor will have little effect beyond a certain point. In the example quoted, if we double the damping factor from 20 to 40, the total impedance drops only from 10.5 Ω to 10.25 Ω, a decrease of less than 2½ per cent.

Also it is almost certain that the loudspeaker which is efficient in electro-acoustic transfer will be correspondingly efficient as a current generator, so that the damping will improve with efficiency.

Bristol. E. J. JAMES, B.Sc.

"Television Aerials"

WE should like to make a few comments on the article "Television Aerials," by N. M. Best and R. O. Beebe, in your August issue.

It appears from the figures and polar diagrams which they give that

they are advocating the design of television aerials so that the maximum available back-to-front ratio occurs at 41.5 Mc/s, so as to give maximum interference rejection on the sound channel. Our view is that as it is common practice to fit noise limiters to television receivers, which are capable of much better noise reduction on impulsive type noise such as ignition interference, the directional discrimination is better arranged to be a maximum at 45.0 Mc/s, so that it can be used to reduce ghost images, which can be removed in no other way, apart from the physical removal of the reflecting objects.

We were particularly interested in their attempts to measure bandwidth, as they have adopted a method differing fundamentally from the one usually employed. We consider their method rather less accurate as they have included the bandwidth of the transmitting aerial in their measurements, since the radiated field will not be constant at all frequencies in the band although the aerial current may be maintained constant. The use of coaxial cable for the receiver and transmitter aerial feeders also introduces a source of error as signals will be picked up on the receiver feeder and radiated from the transmitter feeder due to the balanced termination. This must introduce a considerable error, as the magnitude and phase of this component cannot be estimated. Had a balance-to-unbalance transformer been incorporated in the aerial system, or balanced twin feeder line used, this effect could have been eliminated.

In view of these sources of inaccuracy we do not see how the

authors can have measured a bandwidth flat within 1 db, as the experimental errors must have considerably exceeded this.

F. R. W. STRAFFORD.

J. N. PATEMAN.

Research Dept.,
Belling and Lee, Ltd.,
Enfield.

Filters

THOMAS RODDAM'S remarks in your August issue are surely irrelevant. There is no mention of "ideal wave filters" in H. E. Styles' article.

In effect, Roddam asks us to give up the use of a general descriptive term in order that there shall be no confusion when he uses it as shorthand to mean one particular fictitious conception.

If he belongs to the esoteric coterie of wave filter designers I can understand his difficulty in envisaging an "untuned filter" but practical men will continue to use untuned resistance-capacity circuits to filter out unwanted R.F. from the audio output of a detector stage, and to understand each other when they discuss scratch filters, tunable whistle filters, and untuned resistance-capacity filters for smoothing H.T. supply circuits.

HENRY MORGAN.

London, S.E.1.

Television and Thunderstorms

I AM using an experimental television receiver at this address, about 90 miles from the transmitter. The signal is normally just good enough to enable the picture to be held, and is subject to considerable fading.

It has been observed during the last month or two that for two to three hours prior to the arrival of a thunderstorm in this area the signal has increased to a point where "local station" results are obtained with a complete absence of fading.

This has happened on five or six occasions, and each time the storm has approached from roughly the direction of the transmitter. I should like to know why. Perhaps the effect has been observed by others whose knowledge of propagation at television frequencies is greater than mine. E. G. HILL.

Halesworth, Suffolk.

Purchase Tax on Listening

WHY must a battery set user pay purchase tax on his listening while the mains set user can waste power all day long tax free?

The purchase tax on high-tension batteries should be removed.

ROBERT C. BELL.

Ambleside.

Books issued in conjunction with "Wireless World"

	Net Price	Postage
WIRELESS DIRECTION FINDING, by R. Keen, M.B.E., B.Eng. (Hons.), Fourth Edition, XII + 1,059 pages	45/-	(9d.)
TELEVISION RECEIVING EQUIPMENT, by W. T. Cocking, M.I.E.E., Second Edition	12/6	(5d.)
FOUNDATIONS OF WIRELESS, Fourth revised Edition, by M. G. Scroggie, B.Sc., M.I.E.E.	7/6	(4d.)
WIRELESS SERVICING MANUAL, by W. T. Cocking, M.I.E.E., Seventh Edition	10/6	(4d.)
HANDBOOK OF TECHNICAL INSTRUCTION FOR WIRELESS TELEGRAPHISTS, by H. M. Dowsett, M.I.E.E., F.Inst.P., and L. E. Q. Walker, A.R.C.S., Eighth Edition	30/-	(8d.)
BASIC MATHEMATICS FOR RADIO STUDENTS, by F. M. Colebrook, B.Sc., D.I.C., A.C.G.I.	10/6	(4d.)
LEARNING MORSE. 335th thousand	6d.	(1½d.)
RADIO WAVES AND THE IONOSPHERE, by T. W. Bennington	6/-	(3d.)

Obtainable from all leading booksellers or from

ILLIFFE & SONS LTD., Dorset House, Stamford Street, London, S.E.1.

BOOK REVIEWS

Radar Engineering. By Donald G. Fink. Pp. 644, with 471 diagrams. McGraw-Hill Publishing Co., Ltd., Aldwych House, London, W.C.2. Price 35s.

THIS textbook is not an attempt to supply information on all the ingenious radar devices that were used during the War. Such a mass of detail would in any case be far too voluminous for one book, and would be of very limited practical value. It is a presentation of the underlying principles and commonly-used techniques, illustrated by some typical examples. The reader is assumed to have a basis of conventional radio, but not necessarily of television, pulse techniques, or microwaves.

So the author has devoted a large part of his space to the theory of transmission lines, waveguides, cavities, magnetrons klystrons, beam aeriels, and so forth. He has arranged his material well. After a brief review of radar, which identifies the different methods of scanning and indication, and clearly brings out the significance of the leading variables, such as wavelength and pulse frequency, the theoretical principles are discussed. They are classified broadly into pulse and R.F. principles. The second half of the book deals with applications to the various essential constituents of any radar system—modulator, transmitter, radiator, receiver, indicator, etc. An exceptionally full index completes the book.

Although the term "radar" is used in its strictest sense, so that responders, Gee, and other aids to navigation are not specifically mentioned, and although the sets described in detail are limited to one U.S. Army wartime ground radar system in each of the 200, 600, 3,000, and 10,000 Mc/s bands, the fact that the author has devoted his effort mainly to expounding fundamentals enables his teaching to be applied not only to systems mis-called "radar" but to such fields as television and microwave communications.

It is a pity that a work which is in most respects so good is seriously inaccurate in the most elementary parts of the theory, where the effects of current and voltage pulses on inductance, capacitance and resistance, separately and combined, are described and illustrated. The cases considered are for the most part rather artificial ones and would not be the best introduction to pulse circuit theory even if correct. Several of them flagrantly contra-

dict Kirchhoff's Second Law, as well as the other elementary principles quoted by the author. One of them shows an exponentially varying voltage across a dead-shortened resistance! The author draws attention to the analogy between current and inductance on the one hand and voltage and capacitance on the other, yet if he had applied this analogy himself to the whole series, summarized in Fig. 51, his errors would have been manifest. An extraordinarily involved and wildly erroneous explanation is given of the supposed behaviour of the response of L and R in parallel when a voltage pulse is applied. Coming (much too late, p. 322) to the more practically important differentiating circuit, the leading edge of the voltage peak across R is ascribed to the charge of C, and the exponential trail-off to the discharge. It would have been far better if the author had assumed a knowledge of circuit theory and omitted it, for what has been given is likely either to confuse the reader at the start, or else arouse his doubts about the reliability of the whole book. The more advanced sections that follow are much more satisfactory, however.

Circuit techniques are the weakest in the second half also. The production of sawtooth sweep waveforms is tackled in two places, very inadequately in both, and there is no reference to Puckle's book or other source of more up-to-date information. Linearizing technique stops short at the simple pentode, and there is no mention of the Miller time-base principle, or of the floating paraphase or Schmitt circuits, nor is an anti-astigmatism circuit shown.

These are, perhaps, debatable questions of choice, however, and if the comparatively brief elementary circuit sections are carefully ignored this is a readable, well-arranged, and, for the most part, accurate textbook. M. G. S.

The Metre-Kilogram-Second System of Electrical Units. By R. K. Sas and F. B. Pidduck. Methuen & Co., Ltd., 36, Essex St., London, W.C.2. Price 4s.

REFERENCE is made in this monograph to the fact that many books on physics written recently in the United States have used the m.k.s. system of units, which was adopted by the International Electrotechnical Commission in 1938. The authors consider that a wider use of the system in this country will be of the greatest service to students of physics and

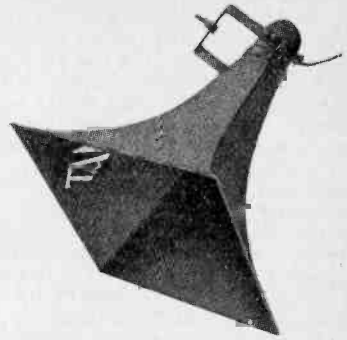

SPEAKERS OF DISTINCTION

The extensive range of TANNOY Sound Equipment now available embodies the latest technical developments in design and performance.

Here are two examples of distinctive Loudspeakers. The one shown above is Type LSH/200/H a weather-proof Re-entrant Horn giving first-class quality reproduction.

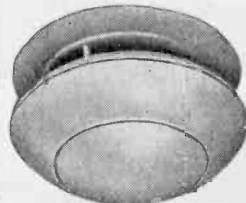

This is Type LS/CIR/5. A Bowl Loudspeaker suitable for Ceiling or wall mounting, combining the latest developments in speaker design with artistic appearance.

TANNOY

—SOUND EQUIPMENT—

GUY R. FOUNTAIN LTD.,

"THE SOUND PEOPLE"

"TANNOY" is the registered trade mark of equipment manufactured by

GUY R. FOUNTAIN LTD.,
WEST NORWOOD, S.E.27.
GIPSY HILL 1131

The largest Organisation in Great Britain specialising SOLELY in Sound Equipment.

Branches at Manchester, Belfast, Newcastle-on-Tyne, Birmingham, Bristol, Glasgow, etc.

Book Reviews—

engineering. If one were starting *de novo* there is little doubt that a single system embracing the practical units and the various electrostatic and magnetic units would be preferable to three separate systems, but when one has been brought up on the electrostatic, the electromagnetic, and the practical system of units, and feels perfectly at home changing from one to the other, the introduction of a fourth system is bound to be confusing. We must confess that if, on opening a text book, we find that the formulæ are based on the m.k.s system, we feel tempted to close it again quickly. The same is true of the so-called rational system in which the 4π is missing from its accustomed place and turns up in unexpected corners.

The monograph under review is divided into nineteen sections each of two or three pages. The first few deal with the disadvantages of

the three systems in use up to the present, with the question of rationalization and with the perennial problem of the relation between H and B. Section 5 is appropriately entitled "Tribulations of the Student": he might have been saved some of these tribulations if the authors had taken a little more care in correcting errors, such as $4\pi\sigma S$ for the electric intensity just outside a conductor which is, of course, independent of the area S . $\Delta \times u$ instead of $\nabla \times u$ for the curl of u and flux where flux was intended. They omit the "per second" and instead of 50 c/s we have such things as $50 c = 314 p$ and frequency of electric oscillations $\omega = 1/(LC)^{1/2} p$, in which p stands for pulses.

On p. 23 the authors do something which one would have thought impossible; they take as their unit of H the ampere-turn per metre and give it the name *oersted*. Now the oersted is already internationally

used as the unit of magnetic force or intensity in the c.g.s. system, and it is quite inexcusable to apply it to another unit. To say that the earth's horizontal component is about 15 Oe when it has for some years been given as 0.18 Oe is to show an utter disregard of recognized nomenclature.

The concluding section consists of a table of formulæ in the m.k.s. system and the reader is told that he "should learn the formulæ and not convert from systems of units which are better forgotten." This may be possible if one has no previous knowledge of the subject, but it will certainly be very difficult for anyone whose whole previous education has been based on the earlier systems.

We must confess that we are disappointed with this monograph and feel that more care should have been taken in its preparation.

G. W. O. H.

Remote Control Components

THE Londex two-step relay performs the functions of the secondary relay described in a recent article.¹ The unit, Type LF/FS/AC measures $7\frac{1}{2}$ in \times $6\frac{1}{2}$ in \times $3\frac{1}{2}$ in and consists of an A.C. relay, fed at 25

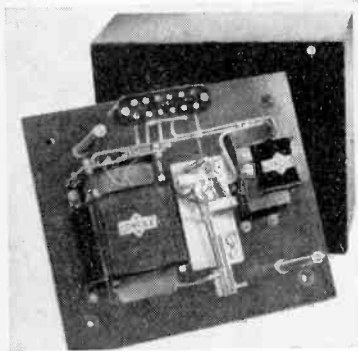

Londex Two-step Relay Unit.

volts from a transformer the primary of which is tapped for voltages from 110 to 250 V. The armature of the relay drives a ratchet mechanism which opens and closes a pair of heavy-duty contacts at successive operations. The movement of the contacts occurs on releasing the relay; i.e., at the end of the current pulse. The transformer and relay coil are continuously rated, so the current pulses may be of unlimited

duration. After being energized on test for 15 minutes, the transformer was quite cold, and the relay coil only warm to the touch. The components are mounted on a heavy insulating base plate and provided with a sheet metal case. A neat terminal block is provided, appropriately marked for connection in a radio receiver remote control circuit. If separate wires are provided for the control leads, no extra equipment is needed apart from push-buttons. The unit is priced at £4 17s 6d and the makers are Londex, Ltd., Anerley Works, 207, Anerley Road, London, S.E.10.

A second piece of equipment is a complete remote control unit. Known as the "Switchmatic, No. 700," it is the product of the Carlton Manufacturing Co., 4, Carlton Terrace, Portslade, Sussex. The circuit comprises a 9-volt battery and 1,000-ohm P.O. Type 3,000 relay which are wired in series and connected across the extension loudspeaker leads. A capacitor prevents current flow through the wireless set output transformer secondary. The extension loudspeaker provides a D.C. path across the extension leads, and the relay is thus energized. In this way control of the receiver is effected without any additional wires. The relay

carries a single-pole "make" contact which is wired in series with the mains lead to the receiver. When the set is "on" (i.e., when the relay is energized) a continuous drain of 9 mA is imposed on the battery. Switching the set on and off is accomplished by a switch at the extension loudspeaker in series with the speech coil. A switch on the "Switchmatic" unit itself is arranged to short-circuit the relay contacts when the remote control facility is not required.

It would be useful if this switch carried extra contacts which also disconnected the battery, as otherwise it is possible, if the switch on an extension loudspeaker is left on, to impose a continuous drain on the battery without being aware of it.

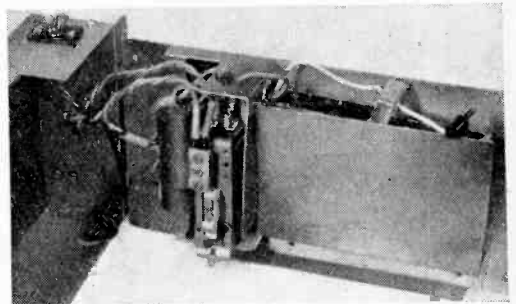

The Switchmatic No. 700 Remote Control Unit.

The components and battery are together mounted in a metal case, $9\frac{1}{2}$ in \times $5\frac{1}{2}$ in \times $2\frac{1}{2}$ in and the price is 64s 6d.

¹ "Receiver Remote Control," *Wireless World*, June, 1947, Vol. LIII, p. 212.

Unbiased

By FREE GRID

D.C. Defence League

IT is an axiom in this or any other country that if you have a grievance, whether it be against the Government or anybody else, you have only to bawl loudly enough and you will get it redressed no matter how imaginary it is. On the other hand, if you don't bawl nothing will be done about your grievance no matter how just your cause. This holds true from earliest infancy, for I personally soon discovered that a hearty yell was far more productive of the good things of life and got them much sooner than any amount of good behaviour.

A noisy and vociferous minority who wants the Government to provide red flannel underclothing for the grass-skirted maidens of the South Sea Islands can, by constantly bombarding M.P.s and Cabinet Ministers with postcards and telegrams, get far more action from them than the patient and silent majority who would rather have some red flannel underclothing for themselves but haven't organized themselves into a body to demand it.

I have been at some pains to make the foregoing clear as there is in this country a long-suffering and patient radio minority for whom the fat and prosperous wireless community at large—including listeners, manufacturers and the hierarchy of *Wireless World*—care not a rap. I refer, of course, to the despised fraternity of D.C. users which is nothing but the Cinderella of the wireless community and will remain so unless the members organize themselves and set up such a yell that something will be done to redress their grievances.

Nowadays, of course, when the grid is groaning under its load, the big cry is that it is no time to think of adding to it. I am, however, willing to wager six bowler hats to a packet of cigarettes that in five years' time, when we may reasonably expect the shortage of generators and electrical transmission gear to be but a dim memory, D.C. users will find themselves in exactly the same position as now unless they get together and do something about it.

The least that can be expected is the provision of A.C./D.C. sets in adequate variety and quantity

until such time as D.C. itself disappears for ever. As it is, one sees dealers' shops crammed to bursting point with post-war models of A.C. and battery sets with here and there a stray A.C./D.C. set holding up its head amidst the obvious sneers of the "A.C. only" aristocracy all around it. I don't know whether it will be the same at Olympia next month and I only hope that it is not too late now for the organizers to get all the D.C. exhibits into one corner of the show instead of leaving us to pick them out here and there in an obscure corner of each stand.

Silent P.A. at Last

IT is gratifying to learn from somebody in a very high position in the railway world that my recent protest against the use of P.A. in our large railway stations to add to the existing nightmare of noise has had the desired effect. In the case of one company, at any rate, serious consideration is being given to an alternative suggestion which I submitted privately to the directors.

In my letter to them I pointed out that since a cathode-ray tube was roughly the same shape as the horn-type P.A. loudspeaker they employ, it would not detract from the beauty and symmetry of the general layout of their stations if they substituted one for the other and installed a closed circuit television system for their announcements. By doing this, several objects would be achieved apart from the elimination of the nerve-wracking noise and irritating reiteration emanating from the P.A. loudspeakers, for in between the announcements the company could sandwich highly profitable advertisements about "Marvellous Margate" and "Soul-Satisfying Southend."

It is, of course, futile to raise the objection that to have train announcements prominently displayed in this manner won't meet the case in the same way as an audible announcement. After all, the most important thing in a railway station is Time, with a capital T, and this is "announced" in a manner perfectly satisfactory to all by means of a silent clock hung up where all can see it. Nobody expects the clock to strike or to contain a hidden loudspeaker constantly bellowing out the passing moment, and everybody would heartily resent it if it

PREMIER RADIO COMPANY

MORRIS & CO. (RADIO) LTD.

ALL POST ORDERS to 167 LOWER CLAPTON RD., LONDON, E.5

'Phone: Amherst 4723

ALL CALLERS to 169, FLEET STREET, LONDON, E.C.4

'Phone: Central 2833

Send 2½d. stamp for list

Terms of Business:

Cash with order or C.O.D. over £1

Philips Amplifiers. Military surplus, soiled condition. Perfect working order, 8 DB 12-volt battery operated, speech only, output 8 watts, push/pull output. Incorporate 220 v. 80 m/a vibrator pack, 35/-.

3 Valves for same (OZ1 and two EL35), 35/-.

High output carbon hand mike for same, 5/-.

2-VALVE SHORT-WAVE BATTERY KIT. A complete kit of parts for a 2-valve receiver, covering 15-600 metres, including valves, coils, dried chassis, H.T. and L.T. dry batteries to last approximately 6 to 12 months. A pair of double headphones and full instructions. Price £3 10s. An extra coil can be supplied, covering 600-1,900 metres, at 4/-.

SUPERHET TUNING PACKS. Completely wired and aligned. 13-40, 40-120, 120-570 metres. R.F. stage, 465 kc/s; 9 connections only. Complete with 3-gang condenser, calibrated, engraved Perplex dial, and S/M drive. Litz wound polystyrene insulation permeability tuned L.F. 7, 7 kc/s bandwidth. Price complete, £3 17/6.

MIDGET RADIO KIT. Build your own midget radio. A complete set of parts, including valves, loudspeaker and instructions. In fact, everything except cabinet necessary to build 4-valve Medium and Long Wave T.R.F. radio operating on 200-250 v. mains, A/C or D/C. Valve line-up, 6K7, 6J7, 25A6, 25Y5. Wavelengths covered 200-557 and 700-2,000. Size, 10 x 6 x 6 in. Completely drilled chassis. Price, including tax, 27 7s. 6d.

SUPERHET MIDGET RADIO KIT. A complete kit of parts for a 5-valve superhet. Covers 16-50 and 200-567 metres, A/C/D/C 200-250 v. 6K8, 6K7, 6Q7, 25A6, 25Y5. Size, 10 x 6 x 6 in. Completely drilled chassis. Price including tax, 28 5s. Attractive bakelite cabinet for either above kits, 25/-.

SHORT-WAVE CONDENSERS. High-grade ceramic insulation, super midget type, single gangs available in 10, 20, 50, 75, (75 pf. has double spindles for ganging). Price 2/6.

2-GANG, in 4, 8, 9.6, 27.1, 50, 75 p.p.c. Price 5/-.

2-GANG. Full size, 160 p.p.c. Price 5/-.

RADIOGRAM CABINETS. Dignified appearance and good workmanship. Size: 31½ in. high, 18½ deep, 33 wide. French polished, veneered walnut. Price £26. Available complete with electric motor, auto stop and magnetic pick-up, £32 13s. 4d.

Ditto with Rothermel Crystal Pick-up, £35 2s. 1d., or with 8 record-mixer changer, £45 7s. 6d.

METERS.

Range.	Ext.	Diam.	Res.	Fitting.	Type.	Price.
300 v.	31"	15K	Flush	M.I.A.C.	7/6	
250/250 m/a.	2"	100	Flush	M.C.D.C.	7/6	
21 a.	2"	—	Port.	H.W.H.F.	7/6	
21 a.	2½"	—	Port.	H.W.H.F.	3/6	

FERRANTI 1 MILLIAMM METERS, 3½ in. external diameter, flush mounting, with self-contained Westinghouse bridge rectifier. Scale marked 0-10 volts with fifty divisions, fitted in well-made wooden box 6 x 6 x 6 in. 35/-.

ALUMINIUM CHASSIS. Substantially made of bright aluminium, with four sides.

7 x 3½ x 2½ in.	4/6	9½ x 4½ x 2½ in.	5/6
10 x 8 x 2½ in.	7/-	12 x 9 x 2½ in.	7/9
14 x 9 x 2½ in.	8/3	16 x 8 x 2½ in.	9/6
20 x 8 x 2½ in.	10/6	22 x 10 x 2½ in.	13/6

MANBRIDGE TYPE CONDENSERS. Huge purchase of military surplus paper condensers. Super quality oil filled.

Capacity	Working Voltage	Size	Price Each	Per Doz.
2 mfd.	1,000	4½ x 1½ x 1	2/6	20/-
2 mfd.	600	3½ x 1½ x 1	1/9	14/-

500 MICROAMP METERS. Moving coil, 2½ in. diameter flush mounting. Available by the following manufacturers: Met.-Vick 500 ohms; Ferranti 79 ohms. Weston 116 ohms. Either type 21/-.

OSCILLOGRAPH POWER UNITS.—Input, 230 volts. Consist of kit of parts incorporating mains transformer, metal rectifiers, voltage doubling condensers.

Type 406.—Output, 1000 v. and 6.3 v., 20/-.

Type 407.—Output, 2000 v. and 4 v., 25/-.

POWER PACKS. Input, 210-240 v. 50 cycles. Output 250 v. 80 m/a, 6.3 v. 3-5 a. Fully smoothed. Contained in substantial screening box, with full wave valve, £2 10s.

Unbiased—did. It will be the same with the television train announcer; people will learn to look up to it as they do the clock and marvel that they could ever have put up with the present horror for so long.



Free Grid, Volta, Henry, Faradia, Mrs. Free Grid.

In Memoriam

IT is with deep regret that I have to record the sudden and untimely death of Alan Gelli who for

seventeen years has been my collaborator in the production of "Unbiased." It was his creative genius which gave birth to the caricature of the classic features of Free Grid as *Wireless World* readers know them, and later of Mrs. Free

won't result in inhibition rather than in exhibition.

Let Them Know

It is certainly about time that we did a little trumpet-blowing, for at the present moment the rest of the world hardly realizes how much our physicists and engineers have achieved in radio, radar and other branches of applied electronics. The main reason is the paper shortage, which has made it impossible for full accounts of all developments to be published—and by published I mean not only printed, but made available to everyone. Take radar: the proceedings of the I.E.E. Radar Convention held last year would have filled every page of *W.W.* for over two years! The remarkable record of achievement which they embody has been put into print in ten special numbers of Part III of the *I.E.E. Journal*; but the number of copies of the journal is limited and the cost of the radar issues to non-members is £3. The I.E.E.

has played its part nobly, producing a magnificent documentation of our country's part in the conception and development of radar; but the paper shortage means that that documentation, though printed, is not really published. Much the same thing will, I fear, be true of this year's Communications Convention. And so, unfortunately it goes on. The ordinary man living in other countries reads little or nothing of discoveries, inventions and developments in electricity made in Britain, and so, not unnaturally, concludes that we're not doing much.

Not Too Good

One of the most valuable things about exhibitions is that they bring foreigners here and let them see for themselves what we are doing. For that reason it is essential that everything possible should be done to enable them to come here without any bother; but that doesn't always happen. One eminent foreign radio-components manufacturer whom I know ardently desired to visit the R.C.M.F. Exhibition and made all arrangements to do so; but the passport visa procedure proved to be so complicated and so slow that he did not receive the necessary

Grid and the family as exemplified in the illustration reproduced on this page.

It will be no easy task to fill his place.

RANDOM RADIATIONS

By "DIALLIST"

Radiolympia

IF it comes up to the hopes and intentions of its organizers, this year's Radiolympia should be the most interesting that we have yet had. To put it in a nutshell, it's to be a radio and not just a broadcasting exhibition. In the past the keen wireless man has had all too few opportunities of making early first-hand contact with new and important radio developments. He could read about them in *W.W.* and *Wireless Engineer*, but unless he had the *entrée* to the Physical Society's exhibition and to that of the R.C.M.F. and other semi-private shows, he could neither see them in concrete form nor put to experts qualified to give the answers the questions which arise naturally from such an inspection. When there was something really new and really important at Olympia he found far too often in years gone by that the stand on which it was displayed was populated entirely by high-pressure (or at any rate medium-pressure) salesmen who probably thought that Ohm was a character in *Twelfth Night* and had, anyhow, had it dinned into them that the state of their firm's current accounts was directly proportional to their pressure upon sales resistance!

Plenty to Show

This year we are promised exhibits, not only by firms concerned chiefly in making various kinds of electronic equipment, but also by Government departments with a

vital interest in communications systems of many different classes. Several firms will also be showing transmitters and communication receivers. The Home Office has fathered during the last year or two outstanding developments in V.H.F. radio designed for police purposes; the B.B.C. has given a lead by producing quantitative data for A.M. and F.M. on 45 and 90 Mc/s; the television transmitters for Birmingham and (probably) Manchester now under construction by the Marconi Company are designed for a bandwidth of 7-8 Mc/s and will ensure on the screens of first-class receivers images unparalleled in the rest of the world for clarity; the Ministry of Civil Aviation can show navigational, blind flying and blind landing appliances unexcelled by those of any other country; at sea the Decca system was recently found by an international conference held in New York to be the best in existence. I won't prolong the list of our radio and radar achievements, though it could be vastly extended. You'll see that we have sufficient material for a whole host of thrilling exhibits. One only hopes that our traditional—and very real—reluctance to blow our own trumpet

OUR COVER

RADAR EQUIPMENT installed on the bridge of R.M.S. *Queen Mary*, which recently made her first transatlantic run after refitting, forms the subject for this month's cover illustration. The console unit of the Metrovick "Seascan" radar is fed by a scanner mounted above the superstructure in a transparent weatherproof dome. In addition to the Metrovick equipment the vessel is, like her sister ship, *Queen Elizabeth*, fitted with Admiralty Type 268 radar.

authorization until the exhibition had closed its doors. That sort of thing is not good.

□ □ □

Those Problems

AS some readers seem to want the answers to the simple problems in last month's notes, here they are. First the two steel bars, one of which is magnetized and the other not. You can find out which is which by arranging them in T formation. When the magnet is used as the "crossbar" there is no attraction between them. Next the direction of movement of the C.R.T. spot when that of the line-scan deflector-coil's field is upwards. The key here is that the beam of electrons is equivalent to a current-carrying conductor, free to move in a magnetic field. You can thus solve the problem by Fleming's Left Hand Rule, if the fertility of your imagination is such that you can picture the beam of electrons as travelling from the screen to the cathode. As I can't quite manage that one, I prefer the Diallist Right Hand Rule, which gives the answer without involving a similar strain on the imagination. Then the fore-finger (field) points upwards, the middle finger (current) towards you and the thumb (direction of movement) to the right. You'll see, of course, at once what the direction of the field of the frame-scan deflector coils must be in order to produce a downward movement of the spot.

□ □ □

A Different Problem

THE question "What is a broadcasting station?" raised editorially in last month's issue involves some queer problems in addition to those mentioned. For instance, suppose I tune in one of the B.B.C.'s beamed transmissions intended for, say, Ruritania or Yugotoblastia, am I thereby breaking the law? Such a station obviously doesn't broadcast; it narrowcasts. Nor are its transmissions intended for me. Yet it is run by the British Broadcasting Corporation and its transmissions form part of the foreign broadcasting service. And, though it is a narrowcast as regards the greater part of the world, it is a broadcast in the countries to which the beam is directed. Then, is it legal to listen to the American transmissions (again not strictly broadcasts) beamed on Europe? And can a medium-wave station which uses an aerial system designed to reduce the field strength of its transmissions in certain directions properly be styled a broadcasting station? It is all very perplexing!

Variable Resistors

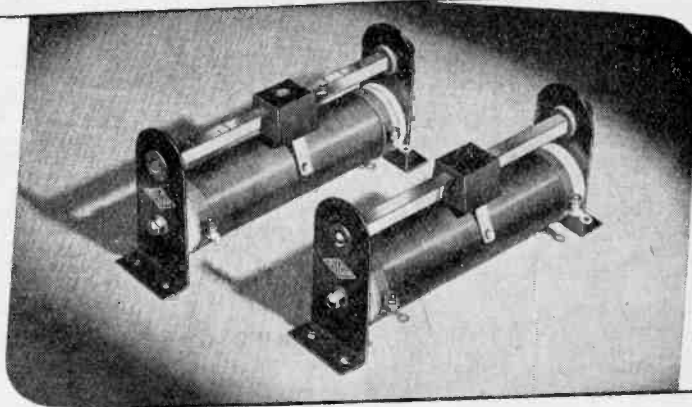

and Potentiometers

THE BULGIN range of 60 Watt heavy-duty potentiometers or variable resistors meets all usual requirements for heavy-loading in radio and light electrical construction, experimental, and test work. Variable contact is smooth and even, and the slider gives continuous contact. The element is linearly wound (tolerance $\pm 10\%$) with finest quality oxide-insulated, non-corrodible nickel-alloy wire, on heat resisting former. The frame is 'dead,' and may be earthed. Available in ratings from 6—50,000 ohms. The 10,000 Ω and 50,000 Ω models have indicator-scale with 0—10 major, and $\frac{1}{2}$ Unit sub-calibrations, increasing the usefulness for servicemen, and in laboratories. Size:— approx. $1\frac{1}{4}'' \times 5\frac{1}{4}''$ base space, $\times 2\frac{3}{8}''$ high. Fixing by 4 holes $\frac{1}{8}'' \phi$ at $5\frac{1}{4}'' \times \frac{3}{4}''$ centres.

"The Choice

BULGIN

of Critics"

A. F. BULGIN & CO. LTD. · BYE-PASS-RD. · BARKING

Telephone: RIPpleway 3474 (5 lines)

RECENT INVENTIONS

A Selection of the More Interesting Radio Developments

RADIO BEACON

TWO dipoles, backed by a common reflector, are alternately energized to radiate a pair of beams which overlap symmetrically about a median line. The whole aerial system is slowly rotated, the carrier wave being modulated from a gramophone record, which announces each compass bearing as the median line passes through it.

The two aerials are switched, by electronic control, at a frequency of 1,500 c/s, and this forms a masking signal which only drops to zero along the median line. Accordingly, as the latter passes through any given listening point the bearing of that point is clearly heard.

W. A. S. Bulement and L. H. Bedford. Application date January 28th, 1944. No. 581576.

BEAM AERIALS

A SHORT-WAVE aerial of high directivity consists of an array of parallel open-ended waveguides W, arranged in echelon. The relative lengths and the cross-sectional dimensions of each of the elements are arranged to ensure that outgoing waves are radiated in phase only in the end-on direction. Similarly, incoming

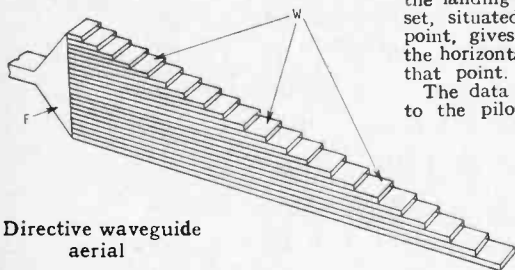

Directive waveguide aerial

signals can build up in phase only when they arrive from that direction. The assembly is connected to a common R.F. source through a flared coupling F, and provides a convenient scanning unit for use in radar.

Western Electric Co., Inc. Convention date (U.S.A.) June 11th, 1942. No. 579773.

SLOT AERIALS

ENERGY flowing through a waveguide is radiated from a slot formed in a metallic disc placed at or near one end of the guide, and at right angles to it. The disc is made of copper or silver, and the length and shape of the slot are such that the aperture is resonant to the transmitted wave. In effect, the field potential is concentrated across the open edges, whilst currents flow in the disc, so that the slot stimulates the behaviour of an ordinary dipole.

The slot may be formed as a straight narrow rectangle, or the two ends may be enlarged and rounded off to resemble

a dumb-bell, the major axis being perpendicular to the direction of propagation and to the electric component of the wave, or a circular aperture may be used. For beam working, the aperture is arranged at the focal point of a parabolic reflector. Formulae are given relating the dimensions of the slot to those of a rectangular guide transmitting a given wavelength.

The British Thomson-Houston Co., Ltd. (Communication from the General Electric Co. of America.) Application date November 2nd, 1943. No. 582328.

BLIND LANDING SYSTEMS

A NUMBER of short-wave transmitter and receiver units are strung out below the ground, where the transmitters radiate a field of uniform strength along the landing line. The transmitters are triggered from a distant control post so as to emit very short exploring pulses, a fraction of each pulse being returned to the control post directly over the feed-line. Echo signals from the approaching plane are also relayed over the same line from the local receivers, so that the time interval gives the control officer an indication of the point-to-point altitude of the craft as it glides down the landing beam. An auxiliary radar set, situated just beyond the landing point, gives similar information as to the horizontal distance of the craft from that point.

The data so obtained is transmitted to the pilot of the plane (after the time intervals have been multiplied in a double-beam C.R. tube) in the form of coded signals superposed on an approach beam of the switched cardioid type.

Marconi's Wireless Telegraph Co., and S. W. H. W. Falloon. Application date, October 5th, 1939. No. 583787.

AERIAL COUPLINGS

THE terminal reactance of a short-wave aerial is converted by the use of a short-circuited half-wave stub coupling into a pure resistance, which gives a substantially flat amplitude-frequency characteristic over a wide waveband, extending say from 100 to 150 Mc/s.

As shown, a pair of half-wave hollow dipoles A, A₁ are each fitted with a coaxial conductor C to form a com-

pensating stub. Current supplied through coaxial feeders F, F₁ flow up the centre wire C and down the inner surface of the hollow dipoles to their outer surface, from which radiation takes place. Condensers K serve to tune the stub to half-wave resonance, so that its impedance is zero at the mean operating frequency, and the aerial load is purely resistive. The inner end of each dipole is tapered, and the two feeders F, F₁ are fitted with quarter-

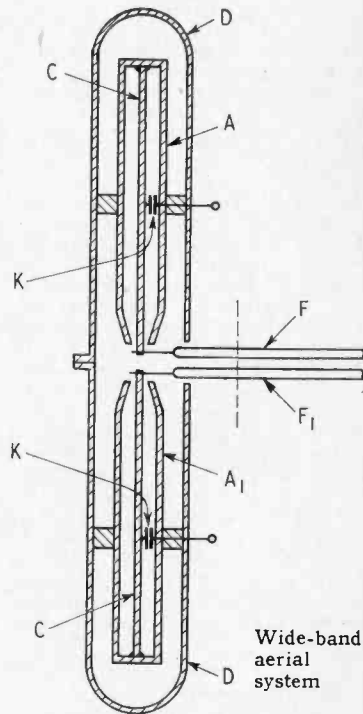

Wide-band aerial system

wave matching transformers (not shown). The dipoles are protected by a weatherproof insulating casing D.

Standard Telephones & Cables, Ltd. and E. O. Willoughby. Application date November 5th, 1943. No. 579778.

VELOCITY MODULATION

IN a discharge tube of the kind in which the electron stream is directed by a magnetic field through the aperture of a tubular resonator for velocity modulation, the control flux from the usual external magnet is strengthened by mounting two auxiliary pole-pieces separately inside the evacuated tube. This shortens the normal width of the field gap. One of the internal poles is located behind the cathode and may be fixed to it; the other is placed at the far end of the resonator and serves as the collecting anode.

For a magnet of given size and weight, the arrangement is stated to provide better control and focusing of the electron stream, with a corresponding gain in operating efficiency.

Standard Telephones and Cables, Ltd.; J. H. Fremlin and R. N. Hall. Application date August 2nd, 1940. No. 579155.

The British abstracts published here are prepared with the permission of the Controller of H.M. Stationery Office, from specifications obtainable at the Patent Office, 25, Southampton Buildings, London, W.C.2, price 1/- each.

1998

Quality

**ACKNOWLEDGED
THROUGHOUT
THE WORLD**



ERIE

Radio & Electronic Components

**RESISTORS • CERAMICONS • Hi-K CERAMICONS • POTENTIOMETERS
SUPPRESSORS • VITREOUS ENAMELLED WIRE-WOUND RESISTORS**

Erie Resistor Ltd., The Hyde, London, N.W.9, England.
Telephone: COLindale 8011-4. Cables: RESISTOR, LONDON.
Factories: London, England • Toronto, Canada • Erie, Pa., U.S.A.

Miniature or Midget

ACTUAL SIZE ACTUAL SIZE

30% 24%

10 1/2% 10 1/2%

XY 1-4 XW 0-75A

NEW TYPES FOR
MIDGET RECEIVERS
HEARING AIDS
METEOROLOGICAL
INSTRUMENTS
ETC.

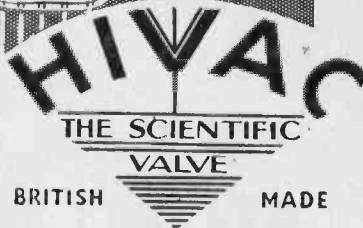

HIVAC LIMITED Greenhill Crescent, Phone HARROW
Harrow on the Hill, Middx. O895

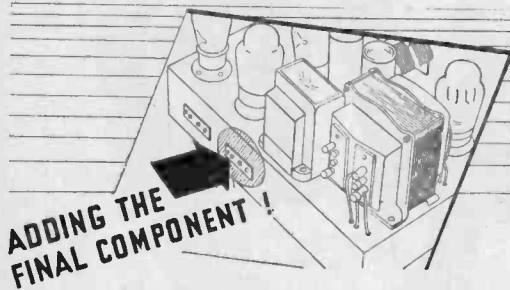

Whether the building of your receiver is a hobby or to provide entertainment in the home, selection of the final component demands the same attention as other details of the circuits. Stentorian Speakers are designed to match any desired impedance. They give such a faithful reproduction that you will at once appreciate the difference.



PERMANENT
MAGNET MOVING
COIL SPEAKERS

Stentorian

PRICES

SENIOR Type BC with Universal Transformer	25	15	6
" " SX minus	25	2	6
JUNIOR Type JC with Universal Transformer	25	0	0
" " JX minus	24	10	6
BABY Type BC with Universal Transformer	22	19	6
" " BX minus	22	13	6
MINOR Type MC with Universal Transformer	22	5	6
" " MX minus	21	19	6



WHITELEY ELECTRICAL RADIO CO. LTD., Mansfield, Notts.

TYPE TRMS - TRANSMITTING

"Cyldon"
TRANSMITTING Capacitors

SYDNEY S. BIRD & SONS, LTD.
CAMBRIDGE ARTERIAL ROAD, ENFIELD, MIDDX.
Phone: Enfield 2071/2; Grams: "Capacity, Enfield."

BOB

SOUND SYSTEMS USED

BSR

THROUGHOUT THE WORLD

BOW

Meet us at
RADIOLYMPIA
OCT 1-11

BIRMINGHAM SOUND REPRODUCERS LTD
CLAREMONT WORKS, OLD HILL, STAFFS.
TEL: CRADLEY HEATH 6212/3
LONDON OFFICE: 115 GOWER ST., W.C.1
TEL: EUSTON 7515

Rate 6/- for 2 lines or less and 3/- for every additional line or part thereof, average lines 5-6 words. Box Numbers, 2 words, plus 1/- Press Day: October 1947 issue, first post Monday, September 8th. No responsibility accepted for errors.

WARNING

Readers are warned that Government surplus components which may be offered for sale through our columns carry no manufacturer's guarantee. Many of these components will have been designed for special purposes making them unsuitable for civilian use, or may have deteriorated as a result of the conditions under which they have been stored. We cannot undertake to deal with any complaints regarding any such components purchased.

NEW RECEIVERS AND AMPLIFIERS

NEW Army 109T car RXs, with 6v vibrator unit; £6/10s, plus 7/6 carr; details s.a.e.—B. Moorcroft, 8, Defence St., Bolton. [8015]

COMMUNICATION receivers.—As soon as civilian supplies recommence we shall be at your service.—A.C.S. Radio, 44, Willmore Rd., Bromley, Kent. [4528]

POCKET size, all-dry s/w receivers, 11 1/2 x 9 1/4 x 1 1/2 in., brand new, c/w, 4 spare valves, phone and aerial, by Crosley's, U.S.A., weight approx. 7lb, price £7 each.—Carbot, Ltd., 201, Long Lane, London, S.E.1.

QUANTITY car radio, 6 or 12-volt operation, easily fitted to any make of car, 14gns, carriage paid; also 8-watt car amplifier, with 6v speaker and hand microphone complete, 10gns.—Radio Unlimited, 16, Carnarvon Rd., Leyton. [7942]

OSMOR A.C.-D.C. 3-wave 5v superhet receivers, excellent reproduction and sensitivity, attractive cabinet, early delivery, shipping waveband if required; write for literature; trade enquiries invited.—Morgan, Osborne & Co. Ltd., Southview Rd., Warlingham, Surrey. [7285]

W.W.W. Quality amplifier (15watt), well built, with first class components and housed in attractive black crackle cabinet, input and output plugs and sockets; complete, ready to work, £24/10; pre-amplifier for I.E.C. or M.C. P.U., £6/10 extra.—M. Helsen, Waverley Cinema, New Milton, Hants. [7991]

WIRELESS WORLD Quality amplifier (page 161, May issue), built with quality parts to specification, tested and guaranteed complete with all valves; £25/10; 12in. speakers and gram. motor supplied to order.—Enquiries to R.T.S., Ltd., Laurel House, 141, Little Ealing Lane, W.5, Ealing 6962 [7691]

BRIERLEY ribbon and armature pick-ups, A filters, amplifiers and pre-amplifiers. Arrangements are being made for the demonstration of these products by agents throughout the British Isles. Where arrangements for this have not so far been completed, it is possible for our sales representative to demonstrate in your own home when next in your district.—J. H. Brierley, Ltd., 46, Titebarn St., Liverpool, 2. [8266]

CHARLES AMPLIFIERS—Announcing a new version of their famous HFA1 amplifier—the HFA3 incorporating a pre-amplifier to enable the use of moving coil pick-ups direct; this amplifier in conjunction with the Lexington moving coil pick-up and the B.A.E.C. twin cone speaker provides the highest obtainable fidelity of reproduction; the complete range now comprises amplifier HFA1 7 watt cathode follower output for crystal pick-ups; HFA2 single-ended 3 watt for crystal pick-up; the HFA3 for moving coil pick-ups; full constructional blueprints, 2/6 each; full kits or separate components available or supplied ready assembled; stamp for comprehensive catalogue.—Charles Amplifiers, 1e, Palace Gate, Kensington, W.8.

RECEIVERS, AMPLIFIERS—SECOND-HAND A.R.77E, good condition, 30mc/s. 550 kc/s; £26.—Box 2141. [8180]

R1155 R.A.F. receivers, excellent condition, 16 to 4,000 metres; £15.

R16 nearly new condition, redesigned and calibrated, guaranteed working order; £17/10. Circuit diagram and component value, 1/6 post free. CAN be supplied with output stage/power pack and loudspeaker; £27/10.

FULLY modified, as follows, becomes an all round super set with high quality output D.F. parts removed, new front panel, bass and treble boost with separate tone controls, R.C. coupled, push-pull output (2PX4s), gram in put, other refinements, complete with loud speaker; £35.—Write for details.

R1155s already purchased, modified and serviced and power packs supplied.—R.T.S., Ltd., 8, Gladstone Rd., Wimbledon, S.W.19. Tel. Lib. 3303. [7003]

PHILCO car radio, 12v model 806T, perfect; 17 1/2 gns.—Epsom 9613 or Box 2031.

R1155 communication receiver; excellent condition; £14.—Box 1325.

Partridge News

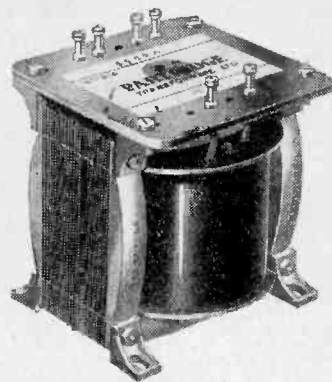

INDIVIDUAL DESIGN

PARTRIDGE Precision Built TRANSFORMERS wound to suit individual requirements now incorporate—Silver plated turret terminals giving a low potential drop and carrying up to 15 amps. Adequate room on each for easy soldering of several external circuit wires.

Firm clamping of the laminations by means of scientifically designed pressure die-castings.

Interlocked fixing feet providing alternative ventilation.

Illustrated above is mounting style "D.N." which can be employed if desired on all components wound to special requirements.

AVAILABLE STOCK

A comprehensive range of mains and audio components is now available from stock, and we can despatch small quantities of these per return. We would stress that before ordering you send for our list detailing these components. Our stock now covers almost all normal requirements, and by availing yourself of this service you will save the inevitable delay in the production of a special component.

The latest addition to this range is a High Quality matching transformer for moving coil pickups (available in a variety of ratios to suit any impedance pickups). Type 402/PU priced at 45/-, employing mumetal core, overall dimensions 2in. x 2in. x 1 1/2in.

Partridge Output Transformer, wound to the specification of Mr. D. T. N. Williamson (Wireless World, May, 1947), £4 3s. 0d.

Telephone:  Abbey 2244

PARTRIDGE TRANSFORMERS LTD

76-8, PETTY FRANCE, LONDON, S.W.1

MARCONI model 878, 1939 all mains push-button; £12.—Clews, Pensham, Pershore, Wores. [8034]

ALEC DAVIS, 8, Percy St., Tottenham Court Rd., W.1, offers the following bargains:—

RECEIVERS.—R.1147 (a. & b.) at 45/-, cases 5/- extra; R.1116, £7; R.5132, £3; type 3 Mk 2, can be operated on 6-volt battery or ac mains; 90-250 volts, £7/15. [8155]

HALLICRAFTERS 836A receiver, 27-145 mc/s, am-fm, s.meter, 110-250v, new; £80.—Box 1401. [8042]

CATHODE ray tube, 12in, in console with time base circuits, H.F. receiver and power units; £30.—Box 2022. [8147]

H.R.O. Senior with national noise limiter, 9 coils, very good condition; offers.—79, Allesley Old Rd., Coventry. [8111]

C.A. AR88 communications receiver, perfect condition with instruction manual; offers over £50.—Box 1406. [8057]

15 WATT amplifier, Callaro turntable and pickup, 12in Goodman's speaker in cabinet; £25 lot.—Box 212. [7747]

EDDYSTONE 504 a/c, hardly used; £50 or near offer; bargain.—Ivan Lenrose, 27, Causewayhead, Penzance, Cornwall. [8017]

TOBE 7-valve communication receiver, 5 speaker and 5 spare valves.—Offers to £10, Moor Park Rd., Northwood, Middx. [8031]

HALLICRAFTERS Skyriker Marine S.22, 110-250v ac/dc, 4 bands, perfect, like new, little used; £40.—Dr. Mellins, Bis. 4554.

1947 "Sound Sales" DN plus seven feeder unit and 12-14 watt amplifier, scarcely used; what offers? (London, S.E.).—Box 1606

A.R.88 receiver, £62; 11H0 180kc30mcs, p-pack, £50; R.107, perfect, £30; R.103A, new, £10; s.a.e.—20, Clifton Av., London, E.17. [8078]

FERRANTI, model 145, also 2 Res Mace extension speakers, as new; nearest offer £20.—Write BM/KYO, London, W.C.1 or ring Ken. 4638. [7999]

RACK-MOUNTED 50watt Savage amplifiers, suitable relay service, transmitter mod. factory installation, etc.—Details from Adams Radio, Long Buckby, Rugby. [8037]

FOR sale, H.R.O. senior with power pack and loudspeaker, 5 sets of coils to cover 7, 14 and 28 megacycle bands, also broadcast bands; £50 or near offer.—Box 1408. [8063]

HAM gear, Hallicrafter SX16, 1req, meter, 30-watt amp, 100 tubes, Xtals, 110v dc, 110v ac, 13.5 amp converter, 3 1/2in C.R.T.; offers.—Buxton, 365, Bellegrave Rd., Welling. [7982]

15 WATT "Wireless World" Bakers' quality amplifier chassis, 2 Bakers' 18in cinema speakers in travelling cases, excellent condition; £25 lot.—Bishop, 177, Kirkstall Lane, Leeds, 5. [8075]

WIRELESS, new, 9in high 12in across attractive walnut cabinet, 5-valve superhet, A.C. only, 200-250 volts, 3 wavebands, long medium, short, 4 watts output; £8 or offer.—Box 2016. [8135]

H.R.O., complete 4 coils, p. pack, spkr., £55; 8v band-switched S.W. superhet, complete. £25; 3 S.W. T.H.F. chassis, £6; quantity components, coils, chokes, meters, condensers, etc.; s.a.e.—Box 1309. [8022]

HALLICRAFTERS dual diversity DD-1, separate 18in loudspeaker and power pack in 33in x 30in walnut cabinet, perfect condition.—Demonstrated at Electron (London), Ltd., 31, Curzon St., W.1, Gro. 1993.

EX-R.A.F. Loran radar sets with 5in electrolytic C.R.T., with time base, 26 valves including 6SN7, 6H6, 6B17, and calibrated 100kc crystal, suitable for conversion to oscillograph; £10.—Apply Box 405. [7797]

7-VALVE Service communications receiver by Pye, new, unused, in original packing, 16-2,000 metres, built-in M.C. speaker, separate power pack; price includes phones, aerial, insulators, spare bulbs and fuses, £28.—Thrupp, 5, Eldon Grove, N.3. [8019]

H.R.O. rack model, power pack, 8 coils fitted in National rack, with enclosed coil container, spare panel for spkr, guaranteed brand new and not used, gift at £65; also RME69, nice cond., £35.—Bentley, 57, Briarlands Av., Sale, Ches [8050]

SUPERIOR radio-record equipment, comprising Cossor superhet, self-contained record player with crystal and M.I. pick-ups, both feeding W.W. Quality amplifier, in own cabinet, with 12in Wharfedale oil mahogany baffle, built 1946 by Incorporated Radio engineer; £50 or best offer.—Box 1314. [7988]

SPECIAL offer, Midget communication receiver and power pack. M.C.R.1 5-valve superhet, complete with aerial and range equipment, lightweight headphones, earth 20-3,000 metres, £9/10; receiver P.109 with 24 valves, £10; receiver P.25 with 11 valves, £5; C.R.T. units, microameters, milliameters, voltmeters, etc., very low prices; send for list; trade supplied.—Wilkinson, Wholesalers, 204, Lower Addiscombe Rd., Croydon, Add. 2027.

YOU can become a first-class RADIO ENGINEER

We are specialists in Home-Study Tuition in Radio, Television and Mathematics. Post coupon now for free booklet and learn how you can qualify for well-paid employment or profitable spare-time work.

T. & C. RADIO COLLEGE
North Road, Parkstone, Dorset

(Post in unsealed envelope, *rd.* stamp)

Please send me free details of your Home-Study Mathematics and Radio courses.

NAME.....

ADDRESS.....

W.W. 63.

10w. MODEL AC/10. 8 gns.

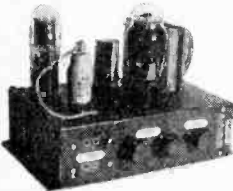

Uses new Mullard EL37, 25w. Pentode. Portable Cased Amplifiers as follows:—AC/18 Concert Gram., 15w., **13 Gns.**; AC/18 HG. Mic. and Gram., **15 Gns.**; AC/25 Mic. and Gram., 25w., **18 Gns.** (This model has separate bass and treble controls.)

Summary Leaflets free upon request.

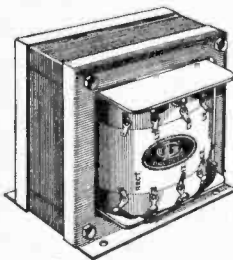

MAINS TRANSFORMERS

For every Conceivable requirement.
Full Catalogues on G. L. Products, 3d.

General Lamination Products Ltd.
Winder House, Bexleyheath, Kent
(Bexleyheath 3021)

VALVES. 1,000 mains and battery, various types, some very difficult to obtain; radio-grams: 5-valve superhet a.c. 200/50. Birdseye, maple and walnut cabinets, from £45 to £65; reconditioned radio sets from £15; hundreds of radio cabinets; 9in c.r. tubes (magnetic), 1½mm sleeving, 2/- doz lengths. 8mid 3/9, 8+8 5/-; 350v-500v speakers, 2½in p.m. 22/6, 5in p.m. 28/-, 8in. p.m. 25/9; all goods carriage paid, c.w.o.; send for lists.—E. A. Porritt, Pleiston Engineers, 134 St. 27, Wastdale Rd., Forest Hill, S.E.23. For. 1292

OVERWHELMING demand for some of our lines has caused delay in replying to our customers and has also cleared out some of our disposal bargains; there are, however, still a number of attractive items of appeal to the amateur enthusiast but remember stocks are limited, so don't delay; R.A.F. radar amplifier, model 1124, complete 6-stage U.H.F. amplifier with 6 valves, 3 Westectors, 3 I.F. stages 6 pre-set R.F. settings, makes an ideal base for television or F/M. experiments, components alone worth £10, our price, £4/10 ea.; class D. No. 1 wavemeter, a few left only, complete with all spares and crystal check unit at £5/5; aerial couplers, type D., complete, at £1/15; R.A.F. dinghy sets, we have a small quantity of these portable transmitters, ideal for amateur field day work when modified, hand driven generator gives 6 volts and 400 volts, 6/7 and 6/6 valves, neon indicator, our price, £2/5; 3-stage amplifier panels for 1T4 type valves complete with condensers, resistors and vol. control, can be made into midget portable by adding tuning device (20% worth of components) to clear at 7/6 each; send stamp for complete bargain list; terms, cash with order or c.o.d. over £2.—Orders to Dept. W.W., Ariel Trust, Ltd., 183, Vauxhall Bridge Rd., London, S.W.1. [8106]

TEST EQUIPMENT

A V O L. & M.W. battery oscillator; offers around £7.—Box 1323. [8012]

WESTON analyser, E665, accas. case; £20.—Nottingham 74490. [8019]

UNIVERSAL valve tester by Bittori and Funke, unused, perfect; £25.—Box 1397.

EMICOL 3-meter analyser and valve tester, £7.—14, Mangrove Ave., Maidstone.

TAYLOR Model 90, perfect condition, £9.—Whitehead, 96, Harpers Lane, Bolton.

NEW, surplus, 0-500 microamp meters, 2in scale calibrated 0-10 volts; price £1.—Box 1438. [8076]

TAYLORMETER 90A, unused since checked by makers; £14.—MacGillivray, Roke, Oxon. [8059]

UNIVERSAL Avo Minor, new; £7/10.—Arrowsmith, 6, Sandringham Rd., Lytham St. Annes, Lancs. [8056]

UNIVERSAL Avominox and leather case, almost new; £7.—72, Bushey Park Rd., Teddington, Middlesex. [8103]

ONE Cossor 339 oscillograph; 1 Cossor 343 ganging oscillator; pair £70 or separately.—Laidler, 21, Galloway Av., Ayr. [8052]

B.P.L. model R.S.600 signal generator, £15; B.P.L. universal test meter with current xfr. £8; both as new, or accept offers.—Box 1612. [8114]

RECORD megger, 500 volts 0-20 megs, brand new and in perfect condition, £10.—Scragg, 15, Sparrow Terrace, Porthill, Stoke-on-Trent. [8009]

COMBINED oscilloscope wobblulator, 3½in tubes, very comprehensive instrument; £35 quick sale, worth £80.—Rogers, 77, Gt. Victoria St., Belfast. [8044]

SELLING out: Taylor meter model 90, Taylor all-wave sig. generator, as new; Zestoscope; s.a.e. list of goods; offers lot or separate: 40 new valves at list price.—I. H. Barnes, 11, Stoney Rock Rd., Leeds, 9, Yorks. [8010]

H. FRANKS, 58, New Oxford St., W.C.1., Tel. Mus. 9594, offers the following equipment to callers only, comprising the following: Lorenz trans-receivers, 41.55 to 45.75 m/cs; ac main driven oscillators, type 37, 22 to 70 mc/s. complete with 6 valves, 807 valve in output stage and milliammeter in output circuit; receiving units, type 69; C.R. units, type P1246; C.R. power units, type 526; performance meters, type 53874; ac mains wave-meters, type W1252; battery wavemeters, type W1095; receivers, type 1147; ac mains power packs for 1147. Receivers 3132; indicator modulators, auto transformers; C.R. units, type 198; receivers, type 76A; battery driven amplifiers, large assortment of volt. amp and milliammeters, neutralizing units with RF meters, metal rectifiers, relays, vibrator packs, inter-com sets, Bendix HF dummy antennas and loading units, complete with RF meters, 356 to 6,666 k/cs; signal generators do to ac converters; Brown's A type headphones; E.M.I. cathode-ray tubes; 6-valve receivers incorporating Clystron unit; ac power units suitable for 1155 receiver; a quantity of Lorenz transmitting gear, ideal for conversion.

Specialists in

HIGH POWER - HIGH QUALITY

PUBLIC ADDRESS SYSTEMS

★
AMPLIFIERS

from 150 W to 1kW

W. Bryan Savage Ltd

WESTMORELAND ROAD, LONDON, N.W.9

Telephone: Colindale 7131



THIS USEFUL NEW FOLDER—

... tells you all about the complete range of Henley SOLOON Electric Soldering Irons, for the standard voltage ranges of 200/220 and 230/250; 65 watt and 125 watt models fitted with oval-tapered bits or pencil bits and 240 watt models fitted with oval-tapered bits are available.

Write to-day for the new folder ref. Y.10 describing



W. T. HENLEY'S
TELEGRAPH WORKS CO. LTD.
(Engineering Dept.)
51-53 Hatton Garden, London, E.C.1

NEW A.F. oscillators, cover 20 c/s to 40 kc/s, mains operated, ex-Govt. stock, £9/10, plus £1/10 carriage and packing; £1 will be refunded on return of packing case. V.S., 42-46 Windmill Hill Rd., Mill Hill. THE following instruments in excellent condition: Evershed & Vignoles 250-volt megger; Universal Avo-Minor; Avo oscillator (mains); Taylor Universal multi-meter (model 90A); Taylor resistance and capacitance bridge (model 110A); what others?—E. H. Luther, Church Rd., Tiptree, Essex. Tel. 44. **2 AVOMETERS**, Model 7 bridge megger, Evershed, Avo bridge, valve tester and D.C. minor wattmeter; Avometer 12; 20w amplifier with mics; 2 A.C. 20w amplifiers; 4 assorted power packs; stulamp; all in exit condition; 3 15ft P.M. speakers (damaged); £108; no offer considered.—Bolton, 28, Union St., Newton Abbot, Devon. Tel. 1070. [8127

NEW LOUDSPEAKERS
T2/1205/15.—Goodman's 12in high fidelity P.M. speakers, brand new, limited quantity available, £6/15 each; cash with order or c.o.d.—T. D. Mackenzie, Wilmar, Collin, Dumfries. [8013
HIGH quality, precision-built speakers, Ticonal magnets, detachable diaphragms, die-cast chassis, twin cone.—Broadcast & Acoustic Equipment Co., Ltd., Broadcast House, Lombard, Norwich 26970. [6435
HOLLEY'S RADIO STORES again demonstrating latest auditorium, including Sound Sales, P.S. Inverter, Goodmans Trivin Co., Wharfedale Golden and 12in, and many others; full range of amplifiers, feeder units m/c, and hypersensitive pick-ups.—285, Camberwell Rd., London, S.E.5. Tel. Rod. 4988.

LOUDSPEAKERS SECOND-HAND
FERRANTI M1+, new condition; £3/10.—Box 2024. [8149
HARTLEY TURNER '215,' as new, £7.—41, Queens Walk, Asford, Middles. [8077
WHARFEDAILE "Golden," latest cone, perfect. £2/15.—Whitehead, 96, Harpers Lane, Bolton. [8100

2 VITAVOX K12-20 PM perf., £10 ea., £19/10 pr.; 1 Goodman's P12E 700ohm with 10w, amp needs att., £7.—Levein, 75, Chesterwood Rd., B'ham, 14. [8077
FOR sale P.A. equipment, 12 watts output, 7 tubes, complete with microphone and stand, amplifier and two speakers, in perfect condition; £20.—Apply 82, Sutherland Rd., West Croydon, after 6.30 p.m.

FULL size Voigt corner horn, black and gold finish, light coil twin unit, W.W. all-wave Super Seven and 12-watt quality amplifier. crystal pick-up, Collaro motor, in mahogany cabinet; best offer £100.—26, Mad Way, Coulsdon, Surrey. Downland 2582. [8131

VALVES
FOR disposal, 6AG5's, 10 in number. Wanted, 1 doz. 1620's or EF37's.—Box 2015. [8133
807, 6L6, 15/-; 12SK7, 6SA7, etc., 10/-; 100 others; 260 service sheets. £5; s.a.e. lists or state wants.—Box 2045. [8099

LARGEST and most comprehensive range in the country, British and U.S.A. types, at Board of Trade prices; send for lists (valves available), free, s.a.e.; valves sent c.o.d.; retailers not supplied.

RANSOM, Bond St., Brighton. [7223
MOST British and American valves in stock, including 1C5, 3Q5, 6A7, 6AB3, 6C6, 6D6, 7B, 18, 42, 43, 25A6G, 35Z4G, MX40, DN41, etc.; please send requirements, s.a.e. list; c.o.d. or c.w.o.—Renall, Eureka, Seagrove Ave., Haying Is., Hants. [8097

RADIOGRAPHIC, Ltd., 66, Osborne St., Glasgow, C.1, mail order specialists.—TX valves, 815 110/-, 805 110/-, 832 79/6. 841 21/-, 866/866A 27/6; RX valves: 9002 10/6, 9003 10/6 VRI50/30 15/-, VRI05/30 15/-, 1625 25/-, R1155A/RX £15/15, plus carriage, with Jones plug and 600 sets; 4U5 pin crystals, 1 holder; 1 1/2 500 K.C. plug-in crystals with osc. coil, 9/6 each; 100 PF TX var. condensers, 2/6 each; micro-indicators, type 2 (includes 500 microamp meter), £2; wameters; W1252 22-3C mcs, W1239 39-50mcs Lab., instruments, individually calibrated, £4/2/6 each; Muirhead dial drives, type 1, 15/6 each; thermo-ameters, 0.350mA, 2in 17/6 each; 16 henrys/200mA, impregnated choke, 10/-; Ferranti 3-ratio P.E. O/P transformer, OPM(C) 7/6; Pyrex bowl type lead ins, 2/6 each; lin Ceramic standoffs, 7d. each; 18in Ceramic strainers with gny pulleys, 1/10 each; T.C.C. 4mid 800v jelly-filled condensers, 4/6 each; 1mid 2,000v, tested 4,000v, Muirhead mica, 7/6 each, list available.—It pays to keep in touch with Radiographic, Ltd., 66, Osborne St., Glasgow. [7950

DYNAMOS, MOTORS, ETC.
BATTERY chargers for home and export. 4 models, 2-6-12v. 1, 2, or 4amp dc, any mains voltage; generous trade terms. Write for catalogue. Tel. Hoddesdon 2655.—The Banner Electric Co., Ltd., Hoddesdon, Herts.

ELECTRADIX

LABORATORY INSTRUMENTS. Portable Weston Substandards Model 155, A.C. ammeter 100 amps zero adjuster, mirror scale, in polished wood case 7" x 6". Weston J multi-range D.C. voltmeter by Weston, 3 v. 150 v. 750 v. zero adjuster, mirror scale, in carrying case. Weston Model I Ammeter 3-15-75-300-1,000 mA 5-15-150 amps with external shunts to match above Voltmeter.

WHEATSTONE BRIDGES. Ex-G.P.O., in new condition, 200 ohms 3-ratio arms and moving coil galvo, flush panel type 25-0-25 on ebonite panel 9" x 6 1/2", with leads and fitted in strong carrying case 16" x 7 1/2" x 6", with carrying handle, £6 10s. Similar type without galvo, £5 5s.

MEGERS. Evershed Bridge Megger with Decade Resistance Box. £35. Evershed Wee Meggers new from stock.

D.C. MOVING COIL BRIDGE GALVO. Flush panel, 2 1/2", scaled, 25-0-25, new, 75/- each.

GALVOS. D.C. moving coil suspension mirror galvo, reflecting type, by Tinsley, 100 ohms, sensitivity 2 1/2 micro amps per 1" of scale at 1 metre, in polished wood case with glass front door, £8 10s. G.P.O. Linesman's Galvo, 25s. Vertical Testing Galvos, 15s.

BOAT MOTORS. 12-volt D.C., work off three 4 1/2 v. dry cells. Weight only 10 ozs, precision made, totally enclosed, as new, 15/-.

MOTORS. D.C. 230-volt D.C. 1/12 h.p. 1,500/2,000 r.p.m. shunt wound by Croydon 25s. 1/40 h.p. 110 v. or 220 v., 17/6. 1/30 h.p. 12-volt with 4-hole base plate, 75s.

MOTORS A.C. 230 volts 1/3 h.p., 4,000 r.p.m. 50 cycles, £9. 1/27 h.p. 230 volts A.C./D.C., 4,000 r.p.m., £15s. 1/20 h.p. 230 volts A.C./D.C. sewing machine type, square construction, enclosed with pulley, belt and bracket, £4 10s.

MOTOR PUMPS. Ledsix 12 volts D.C. for caravan or bungalow; lift 3ft., throw 10ft., handle 100 gallons per hour, £5 10s. 230 volts A.C. Stuart Turner model, 120 g.p.h., £6 6s and £7 10s. Foot valve strainer, 21s.

FANS. D.C. Table Fans, 110 volts, 10" blade and guard, 45s. 12" blade and guard, 55s. Oscillating pattern, 12", 65s. Wall Fans, 18" blade, 200/220 volts D.C., 740 r.p.m., 75s.

TRANSFORMERS. Double wound 230 volts to 12 v. 3 amps, 32/6. 230 volt to 20 v. 2 amps, 30s. 230 volts to 4 v. C.T., 7 1/2 amps, 17/6.

B.T.H. TRANSFORMERS. 200/220/250 volts input, 2 volts 20 amps and 75 volts 6 amps, 15 taps output, 65/-.

BATTERY CHARGERS. We have a large stock of Chargers by leading makers, various sizes, metal or bulb rectification. Send us your enquiries.

TELEPHONES. Wall type constructors' parts, ex-G.P.O., comprising cabinet 8" x 6" x 3", bracket, mike, transformer and condenser, mag. bell, switchhook and contacts, hand mag., ringer P.O. type receiver terminals and connection diagram, 35/- per pair. G.P.O. Candlestick Telephone with receiver and cord, 15/-, postage 1/6. Spare mike insets, 2/6 each.

METAL BOXES. Ex-W.D. stock, 9" x 9" x 8", with 2 front fasteners and loops for carrying strap, plinth for panel, 12/6.

BELLS. Tangent 1/C 230/250 volts A.C., 6" gong, as new, 42/-.

RELAYS. G.P.O. Relays for almost all purposes. Send us your enquiries. Thermal delay relay attachment, 7/6. Mercury Relay Tubes, "On-off," 5 amp, 7/6, postage 1/-.

A visit to inspect our stocks will be time profitably spent!

ELECTRADIX RADIOS

214, Queenstown Rd., London, S.W.8 (late Queen's Road)

Telephone: MACaulay 2159

DO to ac, motor alternators, E.D.C. manufacture, 110v dc input, 220v ac output at 250 watts, screen protected, ball bearings, new and as new; price, £12/10 each carriage paid; others up to 1,000 watts.—Johnson Engineering, 319, Kennington Rd., S.E.11. Resilience 1412-3.

ALL types of rotary converters, electric motors, battery chargers, petrol-electric generator sets, etc., rotary transformers, input 12v d.c., output 600v at 250ma; price £4/10 each, net, post paid; J.A.P. No. 2A engine, 1.2 h.p. at 2,600 r.p.m. complete and ready for use, £17 nett, ex works.—Ward, Lordcroft Works, Haverhill, Suffolk. Haverhill 253/4.

GRAMOPHONE AND SOUND EQUIPMENT LEXINGTON Junr. m/c pick-up and trans., unused.—Box 1439. [8079

FOR sale, Coil moving coil pickup with matching transformer; £4/10.—Box 1410.

LEXINGTON Senior, pickup, transformer, 12in needle, as new £7/10.—1350, Stratford Rd., Birmingham, 28. [8058

FOR sale, V.G. recording motor having 2 speeds, V.G. large tracing gear and cutting head; £25.—Box 1409. [8064

SCOTT Phonom with Garrard auto change, just completely overhauled; nearest one hundred guineas.—Box 1404. [8047

1947 H.M.V. lightweight pick-up with trans. and 70 needles, unused, £4.—McSherry, Newton Stewart, Scotland. [8049

RADIAGRAM cabinet, solid, dual speaker provision, storage 150 records, perfect, £15; motor, pick-up available.—Box 1441.

GARRARD A.C. motor, 12in turntable, pick-up, auto stop, £8/10.—Bolton, Menston Lane, Burley-in-Wharfedale, Yorks.

LEXINGTON Junior pick-up, transformer and pre-amplifier, as new, £7/10, cost £10.—101, Page's Walk, London. [8051

TRANSFORMERS, tone control and filter chokes for all "W.W." circuits.—R. Clark, 30, Langland Crescent, Stanmore, Middx. Wor. 5321. [7532

RECORDING equipment and accessories for the connoisseur, blank discs, cutters, saphires, radio units, mixer units, complete recorder; send stamp for descriptive catalogue.

University Recording Co., 113, Milton Rd., Cambridge, Tel. 54947. [7870

GARRARD transcription motor, 2 speeds, 3 1/2 and 78rpm, latest model 201B mounted on playing desk with Lexington Senior pick-up and battery pre-amplifier, £21, or would consider selling separately.—Dimant, 21, Limes Ave., Mill Hill, London, N.W.7. [8115

BRITISH Sound Recording Association covers all interests of the professional and amateur recording engineer and quality reproduction enthusiast.—Details of information bureau, meetings, publications and membership application form from Hon. Secretary, BCM/BSRA, London, W.C.1. [7772

PORTABLE recording equipment: M.S.S. recording machine, 2C watt amplifier, new, Blank stock; Blank discs, cutting needles, trailer needles, microphones, lightweight pick-ups, matching transformers, speakers, etc.; trade enquiries invited.—Sound Discs (Supplies), Ltd., 83a, Bold St., Liverpool. [6964

ONE Keats-Hacker radiogram, 20 valves, single turntable, 3 ranges short, medium and long waves, fitted Telefunken Sapphire pick-up, bow fronted metal cabinet, 33in long, 2in thick to front, 3 1/2 6in high, loud speaker as separate unit contained in Baffle box 3it 3in x 20 x 13, 16in energised speaker; cost £175, in perfect order.—Offers to Box 1402. [8045

TECHNIFON, Ltd., manufacturers of direct disc recording equipment. Precision built traverse gear complete with first class quality cutting head, £15/15; all types sapphire styli at competitive prices, inc. our IIP model with magnetic shank for all lightweight pick-ups using push-in styli, 9/2 inc. P.T., postage extra.—Technifon, Ltd., 99, Belgrave Rd., London, S.W.1. Tel. Vic. 8814. [8084

TRANSMITTING EQUIPMENT R.A.F. Dinghy TX, type 1333B, perfect condition, £5; complete with diagrams.—Box 1317. [7997

NEW Dural aerial masts, a pair 20ft high 1 1/2 in dia. (would make one 40ft), weight only 7lb, complete with 66ft copper doublet, lead-in, halyards, guys, ground pegs, all made up with fittings ready to erect, finest quality; £5/15.—Harris, Stronds, Pangbourne, Berks.

COMPONENTS SECOND-HAND, SURPLUS SURPLUS to contract.—Large quantity wire and laminations for disposal at cost, gauges 40 to 17 g.s.c., enamel, etc., Jam. sizes Mee 24A, 28A, 29A, 59A, 15A and 4. £500 lots.—Gerrard 6632. A.K.S., 161, Wardour St., W.1. [8119

WEE Meggers, brand new ex-Govt. 250 volt, in leather case, list price £12, our price £8 post free; second-hand ditto, £5; special price for quantities.—Auto Collections, Ltd., 126, St. Albans Ave., Bedford Park, W.4. Tel. Chiswick 1601. [8123

MIDLAND INSTRUMENT Co.

JONES PLUGS with sockets to fit, 10-way, 3/6; 12-way, 4/6. A.M. trimming, etc., tools, set of four, 2/6.

MOVING COIL METERS, high grade 0-1 mA., flush panel mtg., 3 1/2 in. dia., 25/-. Moving coil meters, fitted thermocouple for R.F. 0-2 amp., to match above. 15/-. Both meters brand new boxed.

EX-A.M. D.R. MASTER UNIT gyro compasses, contains three motors, 24-v., one a converter supplying A.C. current to the motor gyro, plus a wealth of other gear, cost over £80, condition as new. 70/- crate and carriage, 7/6 extra.

EX-GOVT. UNITS, fitted 11 valves, VR65A (4), CV6 (2), VR67 (2), VR92 (2), VR54 (1), also relays, var. conds., 50 resistors and 40 condensers, coils, chokes, etc., mounted on chassis 12in. x 8in. x 2 1/4in., fitted louvered cover, condition as new, 40/-, carr. paid.

EX-A.M. R.F. UNITS, types 24 and 25, fitted three VR65 valves, 5-way 3-bank ceramic switch, trimmers, coils, resistors and cond., etc. 25/-; ditto, less valves, 10/-.

EX-A.M. POWER UNITS, type 567, fitted 11 valves, 5U4G (2), 5Z4G (1), 6X5G (1), 6V6G (1), CV188 (2), CV173 (1), VR65 (1), VU120 (1), also three transformers (80-v. 2000-0-c), four chokes, v-controls, high voltage condensers, resistors, etc., steel case, 12in. x 12in. x 8in., weight 3 1/2 lbs., brand new, unused, 70/-, carriage 5/- extra.

NO. 19 A.E. VAROMETERS, includes variometer, 5 mA meter rectifier, 4-v. 10 mA A.C. w/w rectifier, midge 760-ohm w/w v-control, .001 mid. 5000-v. mica cond., knob and enclosed dial, etc., enclosed in metal case. 8in. x 5in., weight 5 lbs., 5/-, post 1/-.

VIREOUS WIRE-WOUND ADJUSTABLE RESISTORS, 8 amp. 17.5 ohms, 25/-, post 1/2.

ALARM UNITS, consists of high grade 2-4-v. bell, VR65 valve, 2000 ohm relay, mains switch, 4 mid. conds., press switch, jack, westerco, coils, resistors, cond., etc., chassis mtg., enclosed in wood case, 6 1/2 in. x 6 1/2 in. x 5 in., brand new boxed, 15/-, post 1/-.

New August lists, 2d. with S.A.E.

Orders over 30/- post paid, no C.O.D. under 20/-

Moorpool Circle, Birmingham, 17

Tel.: HARborne 1308 or 2664

AVO ALL-WAVE OSCILLATOR

or operation on 200 to 250 volts.

DELIVERY FROM STOCK.

This Avo Oscillator is an inexpensive, modulated oscillator having several improved features making it suitable for test room or general laboratory use. It covers a continuous fundamental frequency band from 95 kc. to 40 mc., by means of six separate coils mounted on a rotary turret selector. By this means, the coils not in use are completely removed from the oscillating circuit, thus minimizing losses due to absorption and other causes. Each band is directly calibrated in kc. on a large, clearly marked dial, calibration errors being not greater than 1 per cent. at any frequency. The variable condenser has a modified logarithmic law, thus giving sensibly constant percentage frequency discrimination over the whole scale. The calibrated frequency range is further extended to 80 mc. by a second harmonic calibration of the highest frequency band.

RANGE 1H	30 mc.-80 mc.
1	14 mc.-40 mc.
2	4 mc.-16 mc.
3	1800 kc.-6000 kc.
4	700 kc.-2200 kc.
5	250 kc.-800 kc.
6	95 kc.-300 kc.

PRICE £13. Rail charge, 3/6.

TEST EQUIPMENT.

Universal Avo Minor, 22 ranges, £8 10s.
Taylor 120A Junior, AC/DC, 22 ranges, £8 10s.
Taylor 90A, 1,000 ohms/volt AC/DC, 40 ranges, £15 15s.
Walsall, Model 845, 2,000 ohms per volt, with low ohms range, £14 6s. 8d.
Millard Resistors and Capacity Bridge, 10 ohms to 10 megohms, and 10PF to 10 mid., £15 15s.
Taylor 85A Universal Multi-range Meter, 90 ranges, £19 10s.

B.P.L. SIGNAL GENERATOR.

Frequency range—100-250, 250-600, 650-1,000 kc. 1.6-4.5, 4.5-12, and 12-30 mc. Calibration accuracy 1 per cent. Internal modulation 400 C.P.S., 6 step multiplier and attenuator. A.C. Mains 200 to 250 v. 50-60 cycles, £21.

VALLANCE'S

144, BRIGGATE, LEEDS, 1

Phone: 29428 and 29429.

Stan Call Signs—G2IHW—G8X—G3ABD—G3AHV—G3BDD.

VALUE! Matt has it.

SPECIAL offer headphones, w/lead and jack plug, 5/6 per pair (boxed 2 pairs).

VOLUME controls (Centralab), various values, 1/s 3/6, w/s 4/9; Rothermel crystal pick-ups de luxe, £2/16/3 (inc. P. Tax); metal £2/12/6 (inc. P. Tax); B.T.H. Magnetic P/ups, 33/9, inc. P. Tax; television cable (aerial lead-in), 1/- per yd; a large assortment of B.V.A. and V.S. valves always in stock; let us have your enquiries.

MATT RADIO SERVICE, 29, Castle St., Kingston-on-Thames, Surrey. Kingston 8353.

CHARLES BRITAIN (RADIO), Ltd.

SPECIAL OFFER.—Ex-Army No. 22 set, combined transmitter and receiver, range 35 to 150 metres; this is a powerful set and operates on R/T, C.W. or M.C.W., complete with moving coil mike and head-set and 13 valves; price, carriage paid, £6/19/6; power pack for operating the above from a 12v battery, £1/19/6, or the two items £7/19/6. New list 'WW' now available; send stamp. Full range of standard components, incl. Connoisseur, pick-ups, Rothermel and Aroco Crystal pick-ups, AVO oscillators, Thrush resistance-capacity bypasses, at list prices.—Charles Britain (Radio), Ltd., 2, Wilson St., E.C.2. Tel. Bis. 2966.

ALIGNED INSTRUMENTS SERVICES, Ltd., Colworth Rd., Leytonstone, E.11.

40 COIL pack: A superhet coil pack with an h.t. stage, uses 9 iron core coils in a 16-50, 200-550 and 800-2,000 metres circuit for 465kc/s, i.f., complete with circuit diagram, aligned and gain tested; this coil pack enables the amateur with no signal generator to construct a first-class all-wave receiver; price £3/10. Circuit diagram only, 2/6, post free.

30 COIL pack series: A famous series of precision-made coil packs now too well known to need description. Superhet types: Model 30, 16-50, 200-550, 800-2,000, at 42/-; 30A, 12-30, 50-75, 75-200, at 42/-; 30B, 16-50, 200-550, at 30/-; 30C, 200-550, 800-2,000, at 30/-; 30S, 12-30, 30-75, 200-550, at 42/-; v.r.f. types: Model 30D, 16-50, 200-550, 800-2,000, at 35/-; 30E, 12-30, 30-75, 75-200, at 35/-; 30F, 16-50, 200-550, at 27/6; 30G, 200-550, 800-2,000, at 27/6. Each is complete with circuit. Circuits only, 2/6. [7370]

13 750 hex brass nuts, 4 B.A., 21/64in a.i.x 1/2in; £7/10 the lot.—Barnacle Works, Bensham Lane, Croydon. [8128]

6 BA x 1/4in round head steel screws, 10d per gross, minimum 24 gross; 1/32in brass rod, 1/7 per lb, minimum 1cwt.—E. Aparicio, 115, High St. Epping, Essex. [8109]

MANUFACTURERS and exporters, we offer the following brand new components and high quality tropicalized paper block condensers at bargain prices for bulk purchase:

4mid 400v working, 3,500, £260 the lot; 4+ 2mid 400/250v working, 5,000, £250 the lot; 2mid 500v working, 8,000, £300 the lot; 25 + 5mid 500v working, 800, £20 the lot; push button switches, oak type, 5w, 2,000, £100 the lot; 220v dc—230v ac 300w E.D.C. converters, 30, £300 the lot; 110v dc—230v ac 800w E.D.C. converters, 12, £150 the lot; telephone key switch, push-button, 2-pole, 3,000, £150 the lot; jacks, 4-way, 3,000, £75 the lot; jacks, 2-way, 3,000, £50 the lot; jacks, 1-way, 3,000, £37/10 the lot; water switch, 5-pole, 3-way, 1 ceramic wafer, 500, £25 lot; chokes, R.F. 650 uH, 6,000, £50 the lot; Bargain Radio Stores, 72, Cape Hill, Smethwick, Staffs. [7434]

MINIATURE I.F. smoothing chokes, 6 henries 40 m.a., 350/- per 100; quotations for large quantity from stock.—Ace Electronics, Ltd., Purley Way, Croydon, Surrey. Tel. Croydon 3445-6. [8124]

You will probably get it at Smith's 'Edg-ware Rd.!' Everything for the constructor, from a 1/10watt resistor to a radiogram cabinet; lowest prices, biggest variety.—Near Metropolitan Music Hall, Pad. 5891. [8005]

DOUGLAS h.f. coil winder, with 1/4hp motor, P.B. starter and switch, £22; 12 new reels of approx. 7lb ea.; Lewcos 23 s.w.g. enamelled single Rayon wire; offers; 2 Avo valve panels, £25/10 pair—W. Fothergill, 52, Top Moor Side Rd., Leeds, 11. [7994]

SINGLE and twin screened flex, volume controls, BA screws and nuts, lamination strip, iron dust cores, coil screen tins, main transformers, I.F. transformers, smoothing chokes; lists.—John Downton & Co., 89, High St., Epping. Tel. 2163. [7421]

RADIO metal strip, 0.015x2in, 2/6 lb; 0.010 radio metal strip toroidal cores, 2 sizes, Permalloy dust cores, 2 sizes; 8lydiok 5amp fuse holders, 1/3; terminals, knurled and bakelite covered, 3/- dozen; mains transformers, 350v (1), suitable for mains or battery vibrator working £1 1/- Par. Ltd., 13, St. Peter's Gate, Nottingham. [8113]

RELIANCE POTENTIOMETERS

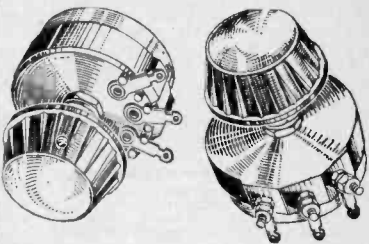

Type T.W. Type T.T.
Continuous Wire-Wound
Rating: 5 watts (linear)
3 watts (graded)
Ranges: 10-100,000 Ohm linear Max.
100-50,000 Ohm graded
100-10,000 Ohm Non-inductive

Characteristics:
Linear, tapered, graded, log., semi-log., inverse log., non-inductive, etc.

Write for full details to

RELIANCE
Manufacturing Co. (Southwark) Ltd.
Sutherland Road, Higham Hill, Walthamstow, E.17
Telephone: Larkswood 3245

'Astronic'
TRADE MARK
BNN Series, single, dual or tri-ally screened Transformers.
Hermetically sealed with soldering spills or with tag panel, both for sub-chassis wiring or with international octal base.



APPLICATION:
Line to grid, line to line, microphone, driver, intervalve, anode to line, etc.

HERMETIC SEALING:
In view of the increasing demand for hermetically sealed versions of the BNN series, an integral glass sealed base has been developed.

Literature, in course of preparation, on request.

ASSOCIATED
ELECTRONIC ENGINEERS Ltd.
DALSTON GDNS. STANMORE MIDDX.
Wardsworth 4474-5-6.

e.h.W.W.

A PERFECT joy to build—The 5-valve ac or ac/dc 3-wave Superhet Assembly (all main components ready mounted on chassis) forms the foundation of a powerful receiver at a price you'll like; send postage now for full details.—N. R. S., 66 Parkhill Rd., N.W.3. 15,000 Selenium rectifiers by S.T.C. and Westinghouse, 5 types, 30 m.a. to 220 m.a., 50 to 360 volts, all new tested stock, substantially discounted for quantities.—Apply for full technical data and prices, Partridge, Wilson & Co., Ltd., Davenset Electrical Works, Leicester. [8120]

BEHOLD! A revolution in superhet coil-packs! Smaller, sturdier, more efficient, higher gain, compl. wired to switch, L.M. & S. waves, for maximum results incorporate one of these in your set; price 33/-; trade enquiries invited.—N.R.S., 66, Parkhill Rd., London, N.W.3. [8035]

LARGE quantity of radio components, including condensers, flexible couplings, 3 pole 3-way switches, line cord, multi-range ohms meters, screened wire single and twin, 3-core flex., 2- and 4-way fuse boxes, etc.—Phone or call L. Goodman (Radio), Ltd., 9, Percy St., Tottenham Ct Rd., W.1. Mus. 0216.

KITS of radio receivers from £7/8; 4 and 5-valve, new materials, table models, semi-midget; our latest kit.—Wylwyn Star 1947 has connections for gramophone pick-up, extensions to loudspeaker A.V.C. 6 hours average time for constructing; full details, diagrams with each kit; c.w.o. or c.o.d.—Isherwoods, Rene House, 81, Plungington Rd., Preston. Tel. 3548. Estd. 1936. [6788]

GOVT. surplus radio units at keenest prices. Admiralty modulator, W6352/4, 7 valves, including 6J58 and 5U4, etc.; ideal for amplifier conversion; 3000 ohm resistance 4/-; R.F. units, type 25, at 20/-; type 27 at 27/-, both carriage paid; large selection cathode-ray and other units, valves, components, etc.; s.a.e. for lists.—Hoyle, 320, Lewsbury Rd., Wakefield. [7993]

HAND microphones by Tannoy & Truvox. New boxed, 15/- ea; headphones, S. G. Brown, 4,000 ohms, 9/5 per pr, 5/6; Henry I.F. chokes, 2 ohm resistance, 3/6 ea; Morganite volume controls, 1 meg, 1/9 ea; American midget volume controls, 100,000 ohms, 1/6 ea; 7-pin Ceramic valve-holders mounted on metal bracket complete with valve retainers, 9d each; 7-pin Paxolin valve-holders, 5d ea; many other bargains; send 2½d stamp for list.—Uncle Tom's Radio Cabin, 5, Seven Stars Court, Manchester, 4. [8160]

GEE ELECTRIC, 15, Little Newport, W.C.2. London, W.C.2. Tel. Ger. 6794.—A few of the many lines held in stock: 32mid 650v w tropical condensers, 12/6; 4mid 800v paper condensers, 5/-; 5mid 2,500v paper condensers, 7/6; 5in page speaker p.m., 16/6 each; 3½in p.r.t., as per last month's issue, £4/10; this month's special ex-Gov. resistor unit type 76, containing relays, i.f.s. fuse holders, also condensers, transformers, modulators, and valve holders, all new, bargain price to clear, 27/6 each; trade supplied. [7886]

FEW examples from latest list; send 2½d s.a.e.—Ferranti I.f. transformers, A.F.3, 21/-; ½ m.a. m/c meters, 21/-; control panels (new), with two m/c meters, switches, etc., 40/-; transmitter coils (P.A.), 3/3; variable 50-1,500v condensers, 7/-; ceramic transformers, 1/6; 2-knob s.d. drives, 5/3; 4mid 1,000 v 2-section condensers, 6/-; R1116 receiver, 15-2,000m battery (callers only); 1,230v 200 m.a., power units, 53/6; input 24v. Dept. W.W., Barnes Radio & Wholesale, 2, Elmdale Rd., Penn. Wolverhampton. [8117]

NEW STC metal rectx., bridge conn. 12v 1a 11/-, 1.5a 14/-, 2.5a 19/6, 4a 23/-, all p.f.; 5a 31/-, p. 1/-, 8-10a 37/5, p. 1/-, 24v 4a 42/1, 5a 64/10, 16m 126/5, 30v 5a 57/10, 50v 5a 81/6, 90v 5a 151/3, all p. 1/3; trans. 200-250m for 6-12v charger, 2.5a 25/-, p. 1/-, 5-6a 48/-, p. 1/6, 8-10a 75/-; carr. 2/- replacements for valve chargers, state make and type and d.c. o/p, 150v slider res., 1-15a 22/6, p. 8d., 40w fluorescents from £6/9/6; 230/150 ½HP ind. motors, £9/5/-, 1/3rd do. £10/5/-; all goods adv. in Aug. issue still available; terms, c.w.o. or proforma; c.o.d. post-goods only.—Pearce, 66, Gt. Percy St., W.C.1. (Nr. Angel). [8262]

JACK PORTER, Ltd.—Radio, guaranteed equipment, ex-R.A.F. 69 receivers, 10 valves, 6 type EF50, 4 type 6Q7, also generator, coils, relays, rectifiers, etc. 70/-; Philco-Masteradio, 6-volt vibrator packs, complete with synchronous vibrators, 15/-; RGD Ekco push-button type radio tuning ac 12-20 volt motors, small new boxed, 20/-; dc/dc generators, 6 volts input 230v at 50ma output, new 17/6, super 12-volt input model, 250 volts 120ma output, ideal for PA, 19/6; ex-R.A.F. receiver model, R.3067, with 11 valves, 6.3 types, 155-185 mcs, amazing, 30/-, complete with valves, cash with order, postage extra.—Jack Porter, Ltd., Radio, 22-31, College St., Worcester. Tel. 2442. [7871]

ARMSTRONG

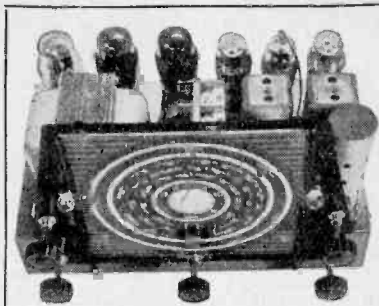

INTRODUCING Model UNI-103 10 VALVE ALL-WAVE SUPERHET RADIOGRAM CHASSIS for D.C. - A.C. mains

Last month we announced model RF103, a very efficient 10 v. Receiver for use on A.C. Mains. Now we introduce Model UNI-103, a 10 valve Receiver for use on D.C. or A.C. mains, particularly, of course, for Listeners on D.C. mains. Whilst we appreciate this is a very small market we feel this new model will be appreciated by customers who are normally limited to the small universal types in their selection of a receiver.

SPECIAL FEATURES.

- ★ 10 VALVE CIRCUIT.
- ★ R.F. PRE-AMPLIFIER.
- ★ WAVE BAND EXPANSION.
(Short wave band covers over 20")
- ★ LARGE GLASS SCALE.
- ★ 3 STAGES A.V.C.
- ★ TREBLE LIFT CONTROL.
(Operates on both radio and gramophone.)
- ★ PLUS 6 db. BASS LIFT ON GRAMOPHONE. (To restore bass cut on some records.)
- ★ 6-WATT PUSH-PULL OUTPUT.

SEE THIS NEW CHASSIS AT RADIOLYMPIA

OCTOBER 1st—11th, on Stand 205

Demonstration model now available for interested callers to hear and technical specifications will soon be ready. It is hoped that a number (very limited, unfortunately) will be available for early delivery. Price has yet to be fixed but every endeavour will be made to keep this below £20, plus purchase tax.

Also on view at Radiolympia our complete new range of radio chassis for home and export markets.

ARMSTRONG WIRELESS & TELEVISION CO. LTD.
WALTERS ROAD, HOLLOWAY, LONDON, N.1.
Phone: NORTH 3213

3 WAVEBAND superhet coil packs with 3 circuit (long, medium and short), 22/6 each; long and medium TRF coils, 6/- pair; long, medium and short wave superhet coils, 7/- per pair; 2-short and medium waveband superhet coils, 7/- per pair; ultra short wave coils, Polystyrene formers, adjustable iron cores, 5/6 per pair; send P.O. with 6d postage to Davis, 9 Windlesham Ave., Brighton 1, Sussex. [7957]

UNIVERSAL ELECTRONIC PRODUCTS (GB)Q, 36, Marylebone High St., London, W.1. Tel. No. Wel 4058. High performance tuning units, covering 16-50, 200-550 and 1,000-2,000 metres, complete with I.F. transformers, valve holders and attractive dial, fully aligned and tested; type A: for 6K8 and 6K7 valves price (less valves) £5/8/6; type B: as above but with addition of third valve holder (for 6Q7), together with volume control, wired, aligned and tested, price (less valves) £6/10/-; postage 2/6; R1155: If you are not satisfied with the performance of your set, write for details of our conversion; our works are available for the construction of specialist type receiving or transmitting equipment to specification; prototype and development work undertaken. [8263]

GOODSELL, Ltd., 40, Gardner St., Brighton, 1, Sussex.—Increased range of feeder units, all incorporating Denco coil turrets and Maxi-"Q" I.F. T's and complete with "E" type valves or equivalent, 0.3 range; C.T.1 1.6 mc/s I.F.T.'s one stage, £9/9; C.T.1 2.465 kc/s I.F.T.'s one stage, £9/3; C.T.2 465 kc/s I.F.T.'s one stage, £15; C.T.3 ready shortly; push-pull quality amplifier, 6L6 with negative feedback. 15 watts output for 0.1 volt input, bass lift, Gardner and Partridge components as standard; de-lux quality amplifier PX 25 outputs, bass and treble controls stabilised power pack; Armstrong chassis; "Q" Max (Berry's) and Maxi-"Q" (Denco) components ex-stock; complete range of components for all stages; send 1d stamp for list; connoisseur pick-ups, ex-stock, £3/18/9, with transformer, 1/- postage. [8073]

SUPERIOR components, mains trans., 230V 50cy, 500-500 170 Mil 4v 4a CT, 30V, 500-500 100ma, 4v 3a, 5v 3a, 6.3v 1a CT, 35/-; 350-350v 200ma, 5v 3a, 30/-; 200-250, 50cy, 6v 5a, 6.3v 7a, 6.3v 8a, 27/6; chokes, 200m 200ma, 140 ohms, 25/-; 5hm 200ma, 110 ohm, 7/6; condensers, paper 8mid, 1,000v w.r.kg, £1; 4mid, 2,000 w.r.g, 12/6, 8mid, 450 w.r.g, tub. cans, 3/6; 16mf, 700v, electrolytics, 7/6; W.W. pots, 3 w.r.g, 4w.r.g, 5K, 10K, 25K, 4/-; chassis, 12½x8x2½ with 5 int. octal and 4 Mazda, oct. valve holders, steel, unused, 7/6; list of smaller gear on application, post free; terms cash, cash refund guarantee, all above post free.—The Television Development Co., 4, The Parade, High Rd., Kilburn, N.W.6. (Adjoining the Kilburn Empire.) Est. 20 years. Tel. MA 3581. [8256]

CORKLIP RADIO, 58, Derby St., Mansfield. Lancs. Cash with order or c.o.d. post free over 5/-. Coughlin Radio is the foremost constructor's service in the country. New goods only; valves, accumulators, condensers (tubular, mica, electrolytic, block, tuning), carbon resistors, mains droppers, line cord, tag boards, fuses, fuseholders, sleeving, solder, soldering irons, Weymouth coil packs, i.f.s. and tuning coils, mains transformers, chokes, output transformers; speakers, P.M. and M.E., 2½in to 12in, feeder units; receiver kits, pick-ups (Rothermel, Connoisseur, S.H.E.F.I. moving coil), sapphire needles, switches (toggle and Xaley), push-back wire and flex, trimmers and padders, signal generators, capacity and resistance bridges, test-meters, microphones, amplifiers, Eddystone components, McCarthy, Raymond and Vidor receivers, control knobs, volume controls, valve holders, etc., etc. Send 2½d. stamp for latest catalogue. [8234]

SPEAKER trans, tapped output, Ultra mid-get 5/-, midget 5/6, standard 8/-; P.P. output (6L6 valves, A/A load 6,600ohms), output 7.5 and 15ohms, 21/-; Ferranti P.P. output, tube duty, 2-1 (massive job), 12/6; Valve class B output, 1.5 and 1.1 7/6; heavy duty P.P. driver, 2.5-1.15/-; chokes, ultra midget 40ma 5/-, midget 50ma 5/6, standard 100ma 8/6, heavy duty 150/200ma 12/6; chassis, fully drilled (4v t.r.f.), 11x4½ 2x2in 6/- (5v superhet) 11½x5½x2½in 7/-; Rothermel crystal pick-ups, 8.8 and S.12. 52/6; volume controls, Centralab, 5,000 to 2meg, long spindle switch 5/-; Paxolin valve-holders English and American 8/- per doz; epicycle drives 3/3; dials S.M.L. 4x3½ 2/-, 5x5½ 2/6; Bernards publication stockist, Television Constructors' Manual, 3/6 etc.; comprehensive lists monthly; 2½d stamp enquiries; postage extra all orders.

O GREENLICK, Ltd., 34, Bancroft Rd., Cambridge Heath Rd., London, E.1. Tel. Stoney Green 1334. [8236]

CRYSTAL PICK-UP

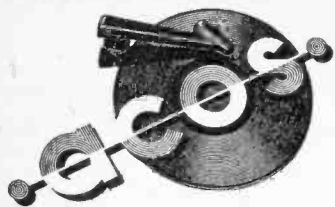

WITH *Unbreakable* CRYSTAL

The ACOS G.P.10 combines purity of reproduction with extreme reliability. A unique flexible assembly renders the crystal virtually unbreakable, while a needle-pressure adjustment is incorporated in the base. Resonance-free response from 50-8,000 cps. Output 1.5 v. at 1,000 cps. Needle pressure 1½ ozs. (adjustable). Vibration-free arm movement. Screened lead. Price in Great Britain 44/- (including P.T.).



Flexible coupling A protects crystal B against breakage. (Brit. Pat. 579,524. Pat. pend. abroad). Licensed by Brush Crystal Co. Ltd.

Obtainable only from Radio Dealers

COSMOCORD LTD
ENFIELD: MIDDLESEX

Aladdin
RADIO CORES
for all purposes
GREENFORD, MIDDx. WAXLOW 2300

THESE ARE IN STOCK

- The Radio Amateur's Handbook, 1947, 12s. 6d. Postage 8d.
- Television Receiving Equipment, by W. T. Cocking, 12s. 6d. Postage 6d.
- Radio Engineers' Handbook, by F. E. Terman, 35s. Postage 9d.
- Radio Receiver Circuits Handbook, by E. M. Squire, 6s. Postage 4d.
- Radio Service Test Gear, by W. H. Cazaly, 6s. Postage 4d.
- Two-Way Radio, by Samuel Freedman, 30s. Postage 9d.
- Radio Laboratory Handbook, by M. G. Scroggie, 12s. 6d. Postage 4d.
- The Wireless World Valve Data, 2s. Postage 2d.

We have the finest stock of British and American Radio Books. Write or call for complete list.

THE MODERN BOOK CO.

(Dept. W.26.)

19-21, Praed Street, London, W.2.

FRITH RADIOCRAFT, Ltd., the Leicester specialists, offer from their comprehensive stocks: Over 5,000 receiving and transmitting valves, including all latest types and many difficult types. Woden transformers ex stock include DTM 11, 12, 13, 14, 15, 16, 17; DTF 12, 13, 14, 16, 17, 19; DCS 13, 14, 16, 17, 18; PCS 11, 12, 13; DT 1, 2, 3; UM 1. Special line ex-manufacturers' mains transformers, 250-0-250v, 60mA, 4v2A, 6.3v3A, 19/6; ditto 295-0-295v, 120mA, 5v2A, 6.3v3A, 22/6. TCC or BI 1mfid 5000v w condensers, size 5x6½x6½in, weight 8½lb each; at the price offered they are cheap enough to parallel for any capacity required in your xmitter power pack; 3/6 each-1/3 post. Button valve holders for 1T4, etc., 1/6. Systoflex, 1.5mm, 36yd hanks, 2/6; 144yd reels, 10/-. Latest lists show many bargains for the constructor, serviceman and amateur, also competitive lines for the trade. We also have in stock over 100,000 spares for all types of British and American radios, for which we invite your enquiries. Trade service dept. for Midlands dealers.

FRITH RADIOCRAFT, Ltd., 69-71, Church Gate, Leicester, Tel. 58927. [7989]

HENRY'S—We have probably the most comprehensive stock of radio spares in London. A stamp will bring our current list. Electrolytics in stock: 8mfid 500 v.w., 4/-; 16mfid 500 v.w., Midget can., 5/-; 16+16mfid 500 v.w. Midget can., 9/-; 16+16mfid 350 v.w. Midget can., 9/-. Valve holders: All types, Amphenol, 7/6 doz; Paxolin, 5/- doz; button type, ceramic (for 1T4, etc.), 1/-; International Octal, ceramic, 1/6 each; Midget 0.0005 2-gang 2½in x 1¼in x 1½in with trimmers 15/6; Wearite P coils in stock, also JF transformers. Main transformers: 80 m/a, 6v and 4v types, available from stock 27/6 each; fully or half-shrouded. Speakers: Special offer, Rola 8in mains energised, 1.500ohm field, with transformer, 36/6 ea; all sizes in stock, 2½in to 8in P.M. Condensers: 2pt to 0.1mfid all at 5/6 doz. Limited quantity only, Mullard DK1 (135), 15010; Mullard D.L. 9 (324), 14/- doz. Over 1,000 new valves in stock; all goods new and guaranteed; cash with order or c.o.d. (over £1). Trade supplied.

HENRY'S, 5, Harrow Rd., W.2. Paddington 1008-9. [8235]

H.T. and l.t. rectifiers, battery charger kits, not surplus, all new goods with full guarantee. New small space type selenium l.t. rectifier for a.c./d.c. sets, 250v, 60ma, takes place of valve rectifier and occupies no more space, 9/6, post 6d.; ditto 120v 25ma for eliminators, 7/6, post 6d., product of famous manufacturer; selenium l.t. rectifiers, with informative instruction sheet, 12v 0.75amp, 7/6; 12v 1.5amp, 10/6, post 4d.; 12v 2amp, 12/6, post 7d.; 12v 3amp, 18/6; 12v 4amp, 25/-, post 9d.; 12v 5amp, 27/6; also new heavy duty aluminium cooling finned 12v 6amp giant type, 32/6, postage 1/-.
H.A.M.P., 43, Orpington Way, London N.21.

SUPREME RADIO, 746b, Romford Rd., S. Manor Park, London, E.12, est. 15 years, Tel. LLF 1260, useful Govt. surplus, set manufacturers' enquiries invited; Mazda valve holders, 54/- gross; 4-pin UX American valve holders, porcelain base, 12/- gross; anchoring tags, 3/- gross; standard gridcaps with lead, 2/- doz; ditto mounted on Paxalin panel with 570 resistance attached to anchoring tag nut and bolt for fixing, 3/- doz; moving coil internal resistance, 250ohms, size 2½in flush fitting, non-splint, glass, £1 each; many other lines not listed; terms cash with order, no c.o.d.; send 6d extra all orders under £25; 2/6d stamp all enquiries and price list. [8260]

SOUTHERN RADIO'S wireless bargains.— Latest radio publications: "Radio Valve Manual," equivalent and alternative American and British types, with all data, 2/6; "Radio Circuits," fully illustrated, receivers, power packs, etc., 2/-; "Amplifiers," fully descriptive circuits, 2/-; "Radio Coil and Transformer Manual," 2/-; "Short Wave Handbook," 2/-; "Manual of Direct Disc Recording," 2/-; "Test Gear Construction Manual," 1/6; "Radio Pocket Book," formulas, tables, colour code, etc., 1/6; "Ten Hows for Radio Constructors," 1/-; Bulgin Radio Service Manual, 2/6; "Radio Constructors' Manual," 3/-; "Television Constructors' Manual," 3/6; "Radio Aerial Handbook," 2/6; "Ultra Short Wave Handbook," 2/6; "Radio Hints Manual," 2/6; "Radio Reference Handbook," cloth bound, fully comprehensive, and covering all available data for radio users and experimenters, 12/6; "Radio Resistor Chart," colour coded values at a flick, 1/-; "American Service Manuals: Crosley-Belmont (Parts 1 and 2), Sparton-Emerson, Stewart Warner-Fada, 12/6 per volume. All publications 3d per each extra for postage.

SOUTHERN RADIO SUPPLY CO., 46, Lisle St., London, W.C. Gerrard 6653. [8267]

BAKERS 'Selhurst' RADIO

18" and 12" P.M. QUALITY SPEAKERS
8 and 15 WATT AMPLIFIERS

TICONAL
MAGNET

12" Model

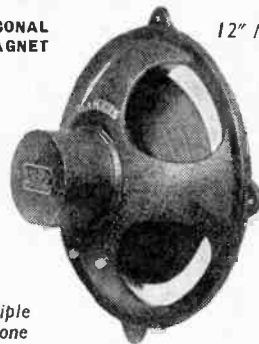

Triple
Cone

PIONEERS OF MOVING COIL SPEAKERS

Improved 1947 MODELS

CINEMA Model - - - £8 19 6
AUDITORIUM Model - - - £8 18 6

Send 2d. stamp for illustrated list to:

BAKERS 'SELHURST' RADIO
75-77 Sussex Road, South Croydon, Surrey
Telephone: CROYdon 4226

A.C.S. RADIO

SPECIALISTS IN AMATEUR AND EXPERIMENTAL SHORT-WAVE EQUIPMENT,

Communications Receivers, Television High quality Amplifiers, Speakers, Aerials, Receiving and Transmitting Valves and Meters, etc.

List "W" free on request to:—

A.C.S. RADIO, 44, Widmore Rd., BROMLEY Kent. 'Phone: RAV 6510

QUARTZ CRYSTAL UNITS

FOR AMATEURS
For your
TRANSMITTER

HIGHER
ACCURACY

COMPETITIVE
PRICES

Delivery FROM STOCK

For your
FREQUENCY STANDARD

SALFORD ELECTRICAL INSTRUMENTS LTD.
PEEL WORKS, SALFORD 3
Proprietors: THE GENERAL ELECTRIC Co. Ltd., of England

GALPINS

ELECTRICAL STORES
408, HIGH STREET, LEWISHAM,
LONDON, S.E.13.

Telephone: Lee Green 0309. Near Lewisham Hospital.

EX-R.A.F. R.F. UNITS TYPE 110A. New and unused, consisting of 5 valves, including grounded grid 750 m/cy. tube, small 12 volt motor and numerous other components, would make very useful cracker, 55/- each, 5/- carriage.

EX-R.A.F. RADAR IMPULSE TRANSFORMERS (new, boxed). We have no actual data on these, but believe them to have an output of 15,000 volts at 3 kV. for a micro second. A bargain for the experimenter at 10/6 each. P.F.

EX-G.P.O. VERTICAL TYPE GALVANOMETERS, centre zero reading 30/0/30, 7/6 each, post 1/-. Mallory 12 volt. vibrators, new and unused, 7/6 each. Electrolytic condensers, 80 mf. 350 volt wkg., 5/6 each, post 9d.

L.T. RECTIFIERS (new), 6 volts, 1½ amp., 7/6 each, 12 v. 1½ amp., 10/6 each, 9d. post. Instrument Rectifiers, S.H., 10 or 20 m/a. types, 4/6 each.

VOLTAGE CHANGER TRANSFORMERS, auto wound, fully guaranteed, immediate delivery, all tapped 0, 110, 220, 240 volts, 250 watts, 45/-; 350 watts, 55/-; 500 watts, 70/-; 1,000 watts, £5/15/-; 2,000 watts, £8/15/-.

SHUNT WOUND D.C., 110 volt motors, 1,500 r.p.m. approx. ½ h.p., condition as new, 17/6 each, post 2/-.

EX-G.P.O. Permanent Magnet Moving Coil speakers (makers Tannoy), suitable for extension or small P.A. work, fitted, in wooden case, 9in. x 9in. x 7in., as new, 27/6 each.

MAINS TRANSFORMERS by well-known makers. Input 200 250 volts, output 700/0/700 v., 80 m/a, 4 v. 3 a 12 v. 1 a., 30/-; Ditto, 300/0/300 v., 200 m/a. 6.3 v. 20 amps. 5 v. 3 a., 45/-; Ditto, 450/0/450 a., 150 m/a. 5 v. 2 a. 6.3 v. 4 a., 37/6; Ditto, 500/0/500 v., 150 m/a. 4 v. 4 a. 6.3 v. 4 a. 5 v. 2 a., 55/-; Ditto 350/0/350 v., 120 m/a. 4 v. 4 a. 5 v. 2 a. 6.3 v. 4 a., 35/-.

AUTO WOUND MAINS TRANSFORMER (Mains Booster). 1,500 watts, tapped 0, 6, 10, 19, 175, 200, 220 225 240 and 250 volts. New ex-Govt. £5/10/0 each carriage 5/-.

EX-R.A.F. AERIAL COUPLING UNITS, absorption type. Range from 1.2 to 5.3 mc/cycles. 7/6 each, post 1/-.

EX-R.A.F. I.F.F. UNIT (Model) 3002, complete with 10 valves types 3X70E, 1E550, 4VR65, 2XYT61A and rotary converter 12 volts input. 450 volts. 40 m/a. output. These units are as new. Price complete, £3/10/-, carriage paid.

EX-R.A.F. CRYSTAL MONITORS, TYPE 2. 3-valve Battery working complete and ready for use, less valves and crystals, operational frequency depends on xtal frequency, condition as new. Price 10/6 each, plus 1/6 carriage. Complete in carrying case, size 8½in. x 8in. x 6in.

EX-R.A.F. MICROPHONE TESTERS. These consist of a Ferranti 2½in. m/coil 0 to 1 m/a. meter with Westinghouse Rectifier incorporated, calibrated at present 0 to 10 volts, microphone transformer, jacks, etc., all contained in polished teak case, size 6½in. x 5½in. Condition as new. Price 37/6 each.

METERS. All first grade moving coil instruments, new, boxed, ex-Govt., 0 to 40 volts, with series resistance removed. 5 m/a, 15/- each; 0 to 10 amps., 15/-; 0 to 1 m/a, 21/-; All 2in. scale and by well-known makers.

EX-NAVAL CATHODE RAY RECTIFIER UNITS. New and unused, sold for components which consist of:—2 x .5 mf. 2,500 v., 1 x .1 5,000 v., 6 x 2 mf. 800 v., 2 x 8 mf. 800 v. 15 volume controls, various valves, approx. 100 small condensers and resistance, smoothing choke and 9 v. holders, including 3 EF50 and 1 tube base. All components wired and with the addition of mains transformer would make a good oscilloscope. Price 55/-, carriage paid.

LARGE RECTIFIERS FOR CHARGING. 6 or 12 volts at 6/8 amps. Complete with mains transformer for 200/250 volts 50 cy. 1 ph. £5/2/6, carriage paid.

EX-GOV'T. NEW MAINS DIMMER RESISTANCE, worm wheel control 700 watts variation from full to Blackout. Price £3/10/- each.

EX-GOV'T. VARIOMETER for No. 19 sets; these contain C.T. Westector, .001, 5,000 v., condenser, etc., price 7/6 each. Complete in metal case with graduated dial.

EX-GOV'T. VARIABLE RESISTANCES. (New), 450 ohms, carry 7 amp., 30/- each, 4,000 ohms, carry ½ amp., 37/6 each.

BARGAINS in new and unused ex-Serviceman equipment.—Indicator units type 6C, containing one 3in cathode ray tube, 2 VR91 (EF50), 2 VR54 (ECC31) valves, 20 various resistances, 4 potentiometers, 8 condensers, co-axial input and output sockets, etc., new and unused, in maker's sealed carton, 5gns each, carriage paid; 40 feet lengths flat twin R.F. feeder ribbon cable with connector, 300 ohm impedance, new and unused, in maker's original carton, 8/6 post paid; ex-R.A.F. type 256, oil filled 4½v. input 230 volts, 50 cycles, output 18kv, weight approx. 4½cwt, in maker's sealed crate, £15, carriage forward.—Wireless Instruments (Leeds), Ltd., 54 and 56, The Headrow, Leeds 1. Tel. 22262. [7766

G. A. RYALL, 65, Nightingale Lane, London, S.W.12.—Mail order only, no c.o.d. under £1, please; postage strictly extra, please write plainly; control boxes size 6x3x3 with Yaxley type switch 2b 4w 2p, with 24in well finished pointer knob, and on/o toggle and DP DT toggle, 5/- each; ditto with two 25ml 25v electrolytics, 10w resistance panel, eight yards twin rubber and screened cable, red pilot light, three plugs, two jacks, good 2-bank 3w 3p switch and knob, size 8x6x2, 10/6 each; also the Type A.M. 404 with three green pilot lights and clear neon type, two relays, 3b 5w light switch, with knob, push switch, internal toggle, four Army type male connectors, size box 10x4½x3½in, etc., 12/6 each, all boxed and new. [8237

RADIO CLEARANCE, Ltd., 27 Tottenham Ct. Rd., W.1. Mus. 9188.—Ex-Army 3b sets, 5-valve trans-rec., range 7.49 mc/s, complete with 2v valves and junction box (as used in tanks with No. 19 set), 45/-; carbon mike buttons ¾in dia 1/6; ceramic conds. 2, 10, 20, 25, 50, 100 P.F. 6d.; silver mica most values 10-6,000 P.F. 6d.; volume controls, carbon, no SW, 10K, 20K, 50K, 100K, 500K, 1m, 2/-; trimmers ceramic 1-15 P.F. 6d, 3-50 P.F. 9d, double U.I.C. type 15-45 P.F. ea 8d, single 3-25 P.F. 4d; padders 150 P.F. 1/-, 750-1,250 P.F. 1/-; 0.2a droppers 3/6; single screened wire, rubber ins stranded cable 8d yd; I.F. transformer 555k 14 pr. [8261

WANTED, EXCHANGE, ETC.
WANTED, fractional h.p. induction motors, preferably sleeve bearings.—Box 2035. [8134

EPOCH loudspeaker wanted, in good condition; please state model and price.—Box 2147. [8193

WANTED, Ediswan C.R.T. type 9 M.H.—Boyd, 81, Hurstfield Crescent, Hayes, Middlesex. [8060

WANTED, condenser drive for pre-war 10-valve Ferguson.—66, Digby St., Scunthorpe, Lincs. [8228

EXCH National PW-2S condenser for old 35mm camera or cash.—Spray, 10, Drove-way Gardens, St. Margarets, Dover. [8008

WANTED, a number of pre-selected tuning mechanisms as fitted to A.F. transmitter types 1154H, 1154M, 1154N; pay 10/- each if good condition.—Box 208. [7741

REQUIRED, any quantity of Niphan sockets, type N549B or any similar 4-pin sockets, waterproof.—Tel. Guildford 3278, or write Ardene Acoustic Laboratories, Ltd., stating quantity available. [8097

G. W. SMITH & Co. (RADIO), Ltd., require the following: new or second-hand radio receivers and radiograms; all classes of radio test equipment; highest cash prices paid.

G. W. SMITH & Co. (RADIO), Ltd., 2, Cecil Rd., Southgate, London, N.14 Tel. Enterprise 5463. [5116

LAMINATIONS in silicon, iron or similar material urgently required in any quantity; any shape to form rectangles approximately 4in x 2in ("L" shape preferred) or sheet material 0.14in or 0.18in thick.—Taylor Electrical Instruments, Ltd., 424, Montrose Av., Slough. Tel. 21381. [8163

WE buy for cash, new, used, radio, electrical equipment, all types; especially wanted, radios, radiograms, test equipment, motors, chargers, recording gear, etc.—If you want to sell at the maximum price, call, write or phone to University Radio, Ltd., 22, Lisle St., Leicester Sq., W.C.2. Ge. 4447.

REPAIRS AND SERVICE.
MAINS transformers rewound, new transformers to any specification.

MOTOR rewinds and complete overhauls; first-class workmanship, fully guaranteed.

F. M. ELECTRIC Co., Ltd., Potters Bldgs., Warser Gate, Nottingham. Est. 1917. Tel. 3855.

MAINS transformer rewound and constructed to any specification; prompt delivery.—Brown, 3, Bede Burn Rd., Jarrow. 3460

LOUDSPEAKER repairs, British, American, any make; moderate prices.—Sinclair Speakers, 12, Pembroke St. London, N.1. Terminus 4355. [5308

LOUDSPEAKERS repaired; transformers, clock coils, chokes rewound; prompt attention; prices quoted.—E. Mason, 5, Balham Grove, Balham, London, S.W. [7667

These Cases

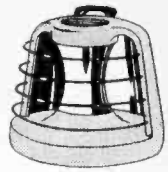

Electric Fire

A case which merely houses its contents is doing only half a job. We specialise in building cases that do a selling job as well.

Make



Radio Cabinet

We can develop and style an individual modern case, exclusive to you, or work to rigid specifications, or supply standard cases from stock.

Sales!



Amplifier Case

We use only materials of the finest quality. And we guarantee to deliver every order on time. Send today or free booklet.

IMHOF'S

PRECISION-BUILT INSTRUMENT CASES

ALFRED IMHOF, Ltd.,

112, New Oxford Street, London, W.C.1.

Museum 5944.

Woodwork by Lockwood

We are Specialists in the Manufacture of high-class Precision Woodwork for the Radio and Electrical Trades and we shall be pleased to receive your enquiries for the following:—

RADIO CABINETS
INSTRUMENT CASES
BAFFLES · HORNS
TRANSIT CASES
LABORATORY
FURNITURE
FITMENTS, ETC.

Timber Licence Required

Lockwood

& COMPANY

67, Lowlands Road, Harrow, Mdx.

Phone: BYRON 3704

TRANSFORMERS & CHOKES

To Special requirements 14 days
High Quality Vacuum Impregnated

AUSTIN MILLS LTD.
LOWER CARRS
STOCKPORT

Telephone: STO. 3791 Established 20 years.

100 kcs.
QUARTZ
CRYSTAL
UNIT
Type
Q5/100

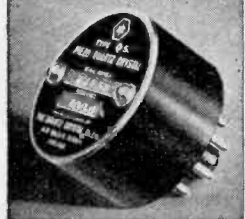

for Secondary Frequency Standards

★ Accuracy better than 0.01%. ★ New grades of cut give a temperature coefficient of 2 parts in a million per degree Centigrade temperature change. ★ Vitreous silver electrodes fired direct on to the faces of the crystal itself, giving permanence of calibration. ★ Simple single valve circuit gives strong harmonics at 100 kcs. intervals up to 20 Mcs. ★ Octal based mount of compact dimensions. PRICE 45/- Post Free

Full details of the Q5/100, including circuit, are contained in our leaflet Q1. Send stamp-to-day for your copy

THE QUARTZ CRYSTAL Co., Ltd.

63-71 Kingston Road,
NEW MALDEN, SURREY
Telephone: MALden 0334

ELECTRICAL measuring instruments skillfully repaired and recalibrated.—Electrical Instrument Repair Service, 329, Kilburn Lane, London, W.9. Tel. Lad. 4168. (6935)

PICK-UPS, replacement coils for Garrard T type, etc.; 5/3; trade enquiries invited.—Radiocrafts, 10, Goodmayes Rd., Goodmayes, Essex. Tel. Seven Kings 4557. [7919]

"SERVICE with a Smile"—Repairers of all types of British and American receivers; coil rewinds; American valves, spares, line cord.—F.R.I., Ltd., 22, Howland St., W.1. Museum 5675. (1575)

LOUDSPEAKER repairs, prompt and guaranteed service; new cones and field coils fitted.—The Leicester Electrical Co., 15, Infirmary Square, Leicester. Tel. 25580. [8186]

REWINDS and conversions to mains and output transformers, fields, etc., from 4/6; pp equipment a speciality.—N.L. Rewinds, 4, Brecknock Rd., N.7. Tel. Arnold 3390. [6283]

LOUDSPEAKER repairs, new cones and L speaker coils, fields, etc., any make, sizes 3in to 18in, complete overhauls; work guaranteed.—Debenham & Humphreys, 18, Buckmaster Rd., S.W.11. [8055]

REPAIRS to moving coil speakers, cones, coils fitted, field rewind or altered; speaker transformers, clock coils rewind, guaranteed satisfaction, prompt service; no mains trans. accepted.

LS REPAIR SERVICE, 49, Trinity Rd., Upper Tooting, London, S.W.17. [4819]

LOUDSPEAKER and transformer repairs "almost by return of post"; we offer the quickest service in the trade, at competitive prices.—A.W.F. Radio Products, Ltd., Borough Mills, Bradford, Yorks. [7167]

STURDY rewinds, mains transformers, chokes and fields; we give prompt delivery and guarantee satisfaction; 14 years' experience; prices on request.—Sturdy Electric Co., Ltd., Dipton, Newcastle-on-Tyne. [4316]

COIL specialists—Tuning and oscillator coils, I.F., E., and mains transformers, chokes, etc., rewind and wound to specification; speaker repairs.—Electronic Services (R.T.R.A. Service Section), Arwenack St., Falmouth.

MIDLAND Sound Reproducer Services; loudspeaker repair specialist, etc.; cone assemblies, voice coils, etc., on all types, British, American (Bell-Howell etc.), Continental and m/o mikes; enquiries invited.—Derby Rd., Lenton, Nottingham. [8169]

LOUDSPEAKER repairs, any make, reasonable prices, prompt delivery, to the trade and quality fans; 25 years' combined experience with Rola, Magnavox, Goodmans, Celestion.—Sound Service Radio, 80, Richmond Rd., Kingston-on-Thames, Kin. 8008. [4977]

REWINDS, mains transformers, speaker field coils, chokes, high-grade workmanship, 7 day delivery; new transformers constructed to customers' specification, singly or in quantities.—Metropolitan Radio Service Co., 1021, Finchley Rd., N.W.11. Speedwell 3000. [3719]

24-HOUR service, 6 months' guarantee, any and i.f.s., etc., all types of new trans., etc., supplied to specification; business heading or service card for trade prices.—Majestic Winding Co., 180, Windham Rd., Bournemouth.

REWINDS, mains transformers, layer wound wax impregnated, O/P transformers, chokes, fields, clock coils, pick-ups, fractional hp motors, competitive prices, prompt delivery; guaranteed work.—W. Groves, Manufacturing Electrical Engineer, 154, Icknield Port Rd., Birmingham, 16. [4547]

TRANSFORMERS, chokes, etc. of every description rewind, quick service; all rewinds carefully tested on elaborate test equipment before despatch; new transformers to any spec. "Wireless World" transformers a speciality.—Radio & Transformer Services, Manchester Rd., Hollinwood. Tel. Fai. 2507.

REWINDS and transformers to specification, any size or quantity; qualified consulting engineers with first-class laboratory available to solve your problems; sub-chassis to order; specifications worked out if required.—Millett & Holden, Ltd. (formerly Diskin & Holden, Ltd.), 2, Pembury Rd., Westcliff-on-Sea, Essex.

REWINDS—Armatures, fields, transformers, pick-ups, vacuum cleaners, gram. motors, speakers rewound new cones and speech coils. All guaranteed and promptly executed. New vacuum cleaners, most popular makes. Send stamped addressed envelope for list of radio spares and c.o. service.—A.D.S. Co., 261-35, Lichfield Road, Aston, Birmingham, 6. [8238]

NATIONAL RADIO SERVICE & TELEVISION CO—Trade service engineers; immediate service any district; rewinds to all types transformers, armatures, motors, loudspeaker cones, speech coils fitted; British and American components and valves; enquiries invited for contract trade service; multiple transformer winding.—63, High St., St. John's Wood, N.W.8. Primrose 6725

LASKY'S RADIO

OVER 6,000 RADIO VALVES IN STOCK. Here are a few examples: 25 A6G, 48, E9F, 1D6, 25Z6, 26Z6 CBL31, EBL31, EBL1, Pen 36C, CL33, 6A8G, 6X8G, 50L6, 3D4GT, VZ2, Z7, Z7, 4Z, 8D, TDD4, ACP, PENDING, UR1C, UR3C, OV21, FQ15, ECH3C, ICH, 1X5, 6BN7, BL33, 12J5GT, 12AG 6T, Y63, 8P4B, ECH31, ECC82, TDD4, VP2B, EBL21, ECH21, UCC31, MX40. All new and unused at B.O.T. prices. WE HAVE THE VALVE YOU WANT. Order C.O.D. or Pro-Forma Orders over £5 post free.

ELECTROLYTIC CONDENSERS
8 mid. 350 v.w. Tub. Cardboard, 3/- each.
8 mid. 500 v.w. Tub. Waxed Card, 3/6 each, 36/- dozen.
8 mid. 500 v.w. B.I. Block Cardboard, 3/6 each.
16 mid. 450 v.w. Tub. ALU. Can, 4/9 each.
8-18 mid. 450 v.w. Tub. ALU. Can, 6/3 each.
8-8 mid. 500 v.w. Tub. ALU. Can, 5/9 each.

ELECTROLYTIC BIAS CONDENSERS.
T.C.C. Microtap, 25 mid. 25 v.w., 2/6 each.
50 mid. 12 v.w., 1/9 each.

Dubilier Drlitic 50 mid. 50 v.w., 3/6 each.
75 mid. 12 v.w., 1/6 each, 12 mid. 50 v.w., 2/- each.

ALL TYPES OF GRAMOPHONE PICK-UPS in stock. Magnetic, Crystal, Moving Coil, Rothermel, Accos, Cosmocond, Lexington, Goldring, B.T.H., etc.

ALL TYPES OF VALVE HOLDERS. Octal, Mazda Octal, English and UX, etc. Button Types holders for 1L5, 7T4, etc. Ceramic, 1/- each, 15/- dozen.

EFSO Valveholders. Ceramic 1/- each, or 9/- dozen.

MAINS TRANSFORMERS. ALL TYPES. 275-0-275 v. 80 m/a 6.3, 2.5 amp. and 5 v. 2 amp., 300-250 v., with mains adjustment. Price 27/6 each, 350-0-350 v. 80 m/a, 6.3, 2.5 amp. 5 v. 200-250 v., with mains adjustment. Price 29/6 each.

ALL TYPES OF P.M. AND ENERGISED SPEAKERS. 5in. P.M., 16/9 each; 8in. P.M., 21/- each; 6in. with O/trans., 27/6 each.

LARGE STOCK OF RADIO TEST GEAR. By AVO, Taylor, Pulin, G.E.C., etc. Immediate delivery.

AVO All-wave Oscillator, £13, A.C. Mains. Owing to the lack of advertising space, we are unable to advertise all the goods we have to offer. Send 1/- stamp for our current list and bulletin.

ALL ENQUIRIES INVITED. Let us quote for your needs. Satisfaction guaranteed or money refunded.

TERMS: C.O.D., Pro Forma or C.W.O.

LASKY'S RADIO

370, Harrow Road, Paddington, W.9

(Opp. Paddington Hospital.) Tel.: CUN 1979

Hours: Mon.-Sat. 9 a.m. to 6 p.m. Thursday Half-day



THE "FLUXITE" QUINS AT WORK

*With FLUXITE, I'm an ace
At soldering things in place.
Don't look alarmed
Our set's not harmed,
want to hear more bass!*

See that FLUXITE is always by you — in the house — garage — workshop — wherever speedy soldering is needed. Used for over 30 years in Government works and by leading engineers and manufacturers. Of all Ironmongers—in tins, 10d., 1/6 & 3/-.

TO CYCLISTS! Your wheels will NOT keep round and true unless the spokes are tied with fine wire at the crossings AND SOLDERED. This makes a much stronger wheel. It's simple—with FLUXITE—but IMPORTANT.

The FLUXITE GUN puts FLUXITE where you want it by a simple pressure. Price 1/6, or filled, 2/6.



ALL MECHANICS WILL HAVE

FLUXITE
IT SIMPLIFIES ALL SOLDERING

Write for Book on the ART OF "SOFT" SOLDERING and for Leaflets on CASE-HARDENING STEEL and TEMPERING TOOLS with FLUXITE. Price 1d. each.

FLUXITE LTD.

(Dept. W.W.), Bermondsey Street, S.E.1.

DEGALLIER'S, Ltd.—Service with a guarantee. If you cannot get your receiver serviced, let American specialists do the job; first-class workmanship only; specialising in Air-King, Belmont, Challenger, Delco, Detrola, de Wald, Emerson, Ferguson, Garod, Hammerlund, Hallcrafter, Lucille, McMurdo Silver, Midwest, Majestic, Pilot, Palico, Scott, Spar-ton, Zenith, R.O.A., etc., also any British set; due to lack of accommodation, our service branches are still dispersed; therefore apply for forwarding instructions before despatching sets; s.a.e. with all enquiries.—Degallier's, Ltd., BCM/DEG9, London, W.C.1 [8043]

MISCELLANEOUS

"W.W." since Dec. '43 (not Sept. '44); £2.—Powell, Riverview, St. Ives, Hunts.
LIMITED number s.a.e. tuning hearts mounted on 5-valve chassis, s.a.e. brings details.—Box 1440. [8081]
ALUMINIUM chassis and panels, plain or punched, from 3/9 each.—Mead, 13, Hence Lane, Darton, Barnsley. [8116]
FROTZHEIM Rudert automatic coil wind-ing machine, power-driven; also Eta wave winding machine.—Box 2019. [8139]
RADIO amateurs: Have your call signs re-corded; details 2/6d stamp.—O Paragon Sound Studios, 66, Queens Rd., W. Croydon.
MIDGET cabinets to your design, reason-able prices, prompt delivery; s.a.e. for details.—35, Colebrooke Ave., West Ealing, Middlesex. [8241]
TRADE inquiries invited for radiogram cabinets; moulded midget radio cabi-nets; chassis, speakers, etc.—Radio Unlimited, 16, Carnarvon Rd., Leyton. [8207]
COSSOR Radio Service Rack comprising rack, freq. and amplitude modulated oscil-lator, model 339 D.B., oscillograph and kit of eads, hardly used; £70 or nearest.—Box 2211.
SCREENED multicore cable, 8 conductors (2 S heavy), rubber insulation, one 50yds length, two 20yds lengths, condition perfect, ideal for H.F. work, worth 7/6 per ft.; what offers?—Gardiner, 130, Mile Cross Rd., Nor-wich. [8252]
RADIO cabinets, Midget type, hand made and polished, front veneered in figured walnut, chrome speaker bars, dial cut to right 4x4, 12x7x6 internal, exclusive design, 32/6, inc. dial; c.w.o.—C. P. Burman, 64, Reighton Rd., Clapton, London, E.5. [8225]
WIRE recorder, unrepeatable, one only, com-pletely portable mike, etc., for receiving, playback, wipe-out, incorporates super-sonic bias; best offer over £85 cash; possibly con-sider exchange first-grade fully professional recording amplifier.—Box 2014. [8132]
PRESSPAHN—Paxolin—Laminated bakelite, etc., squares and strips, wide variety, useful for workshop; per lb, 3/6; special assorted 5lb sample parcel, 12/6, post free.—The Television Development Co., 4, The Parade, High Rd., Kilburn, N.W.6. Tel. Mai 3991. [8257]
AMERICAN magazines available.—F.M. and Television, 30/-; Radio Craft, 16/6; C.Q. (Amateur Radio) 18/6; Q.S.T. (Amateur Radio), 21/6; Radio News, 25/-; Audio Engi-neering, 17/6, incl. one year.—For full list of radio and other magazines send s.a.e. to Willen, Ltd. (Dept. 52), 120, St. George's Rd., London, E.10. [8239]
EX-GOVT. elec. lamps, brand new, ring makes; one million in stock at approx. 75 per cent. off list prices; 2 volt to 230 volt; 0.2 watt to 1,500 watts; various caps; Prefocus projectors, 12 volt to 230 volt; send for list; special prices for export, etc.—Auto Collections, Ltd., 126, St. Albans Ave., Bedford Park, W.4, Tel. Chiswick 1601. [8122]
SCANNING unit, incl. lens tube and slit P.E.C. exciter lamp, supply transformer, £5 or offer.—22, Hurst Ave., Horsham. [8086]
SPARKS' data sheets offer the widest range of tested and guaranteed designs, in full-size data sheet form, obtainable in this country.
TINY Two just released, a 2-valve all-dry self-contained portable, med. waves. **DESIGNED** for individual listening to local stations on speaker, size 5 1/4 x 5 1/2 x 5 1/4 in, 18-volt HT; 2/6.
THREE-VALVE all-dry portable, m/1 waves, 9x6x4in, a most popular set; 2/6. Send a stamp for full list (W).
SPARKS' Data Sheets (W), 9, Phoebeth Rd., Brockley, S.E.4. Tel. Lee Green 0220. [6509]
MIDGET set cabinets, inside 10 1/2 in x 5 1/2 in, enamelled usual colours, with speaker fret, no dial cut out; 12/6 post free.—Morris, 9, Wicklow Ave., Stockport. [7983]
WAVE winding machines for hand or power operation, fully automatic, fully adjust-able; also hand feed straight winders.—Symax, Ltd., 29, St. George's Rd., Reading. [8062]
WE can supply ex stock some 7 or 8 different patterns iron dust cores; please send us your sample for our quotation.—John Downton & Co., 89, High St., Epping. Tel. 2163. [7109]

In the interests of better quality...

The LABYRINTH LOUDSPEAKER (TYPE S. L. 15)

... for Music Societies—Schools Theatres — Quality P.A. — and all music lovers

A partitioned cabinet to form a folded pipe—the back of the unit coupled to it in such a way that the quarter and half wave resonances are under in-dependent 'Q' control—cabinet acoustic resonances arranged to cancel pipe anti-resonances. The result is a smooth bass response down to 35 c.p.s.

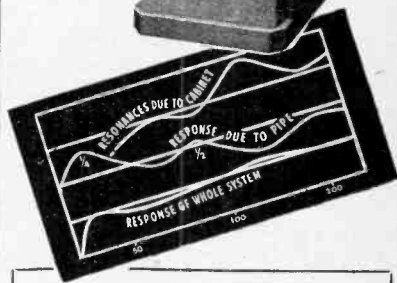
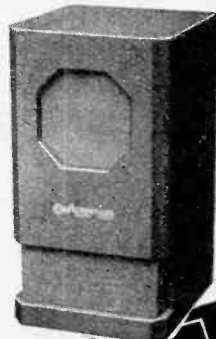

"ADDRESSING the PUBLIC"

The Fundamentals of good P.A. Technique

3/6d. POST FREE



ACOUSTICAL MANUFACTURING CO., LTD. HUNTINGDON Telephone: HUNTINGDON 361

WAVEMETERS.

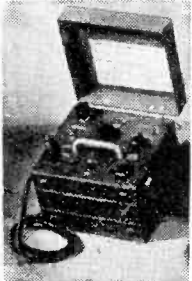

Ex Govt. Class D No. 1 Mk. II, Frequency range 1900-8000 kcs. with check frequencies up to 25 mcs at 1 mcs intervals. Incorporates Dual Crystal 100/1,900 kcs, and ensures 2 kcs accuracy. Operates from 6 volt battery, but readily convertible for 6 volt A.C., details on request. Complete with 2 vibrators and 2 valves, Instruction Manual, and padded

teak carrying case. BRAND NEW ONLY £6 15 0 carriage paid, or few only less the spare vibrator and valve 85/- (carriage 3/6.) Illustrated leaflet sent on request.

R.A.F. T1154 TRANSMITTER OUTPUT UNITS.

The complete output unit for the T1154 Transmitter made to replace faulty items but never used. These are BRAND NEW in Manufacturers Cartons and are choc full of Transmitting Gear. Contains Coil Condenser Assembly for Power Amplifier for All Frequency Ranges, 2 sets of Station Selecting Mechanism, 2 .0002 mfd. Transmitting Condensers, Variable Inductance, Stud Switching, short wave coils, instrument type coloured knobs, etc., etc. ONLY 24/6 (carriage 3/6). Illustrated leaflet available.

THE RADIO CORNER (U.E.I. Corpn.)
138, Gray's Inn Road, London, W.C.1
TELEPHONE 7937.

(2 mins. from High Holborn, 5 mins. from Kings X). Open until 1 p.m. Saturdays. S.A.E. brings current lists.

Beethoven
ROTARY CONVERTORS
220 D.C. to 220 A.C.
Details from—
BEEHOVEN ELECTRIC EQUIPMENT LTD.
Beethoven Works, Chase Road London, N.W.10

"VIBRO-ARC" Engraving Pen
15/-
For rapid engraving any metal—hard or soft.
Operates from 4-6v Post Battery or A.C. Transformer giving 6-10 amps.
HOLBOROW & CO.,
8, Mossley Avenue, Wallisdown, Bournemouth.

WARD ROTARY CONVERTERS
For Radio, Neon Signs, Television, Fluorescent Lighting, X-ray, Cinema Equipment and innumerable other applications
We also manufacture:—
Petrol Electric Generating Plants, H.T. Generators, D.C. Motors, etc., up to 25 K.V.A.
CHAS. F. WARD
LERDSCROFT WORKS, HAVERHILL, SUFFOLK
Telephone: Haverhill 253 & 4.

BRAND new A.M. surplus 2-volt radio accumulators at less than half the usual price, 5/6 pos paid; trade supplied.—Dept. S., Enfields, High St., Midsomer Norton, Som.
DOUGLAS automatic coil winder for sale. Type 3, quite new and unused, complete with motor and countershaft, all mounted on substantial bench specially built.—Offers EME, W.C.1. [8086]

THE set you have been waiting for. Borset 4-valve all-dry portable (superhet), medium and long wave, new MSS: 4 sheets clear-cut drawings, 6 "flow to do it" photos, point to point wiring instructions and parts list; price 3/6 post free.
NOT Spot (no electric mains) soldering outfit, 5/6; other Dorset circuits, 5-valve a.c., 1, m. and a. wave superhet, also a.c./d.c. model, 4-valve all-dry battery superhet, 6-8 watt a.c./d.c. amplifier, 2/6 each; theoretical circuit of sets with price list, 2/6 each.
WELDONA RADIO ACCESSORIES, Ltd., 49, North St., Portlisle, Sussex. [7758]
FOR sale, P.V.C. sheathed cables, screened copper wire braided and polythene core, conductors from 1/022 to 7/032; also lead sheathed solid polythene with single conductors and semi-air-spaced poly. spider copper wire braided and P.V.C. sheathed, large quantities, new condition.—Box 206. [7735]

WORK WANTED
LIGHT press capacity available up to 25 tons, and assembly, in London area.—Box 1437. [8074]
LIGHT assembly work of chassis and components carried out to high standards; work guaranteed; very fair terms; good delivery.—Box 1315. [7952]

FIRM, fully equipped, has capacity available for manufacturing radio cabinets and chassis to customer's specifications, individual or quantity orders.—Box 2017. [8136]

WE make wireless and radiogram cabinets for home and export; immediate deliveries.—Radac, Ltd., 26, Brondesbury Rd., London, N.W.6. Maida Vale 8792. [8025]

CAPACITY available press tools, plastic moulds, jigs and fixtures; production, 750 capstan capacity.—Blair Tool Products, 112, Greyhound Lane, Streatham, S.W.16. [7959]

QUALITY enthusiasts! Have that new high fidelity set you are contemplating designed and/or built by a specialist; all types of apparatus built to requirements.—Write for quotation to BCM/111F1, London, W.C.1.

CAPACITY available for electrical and radio instrument assembly, wiring and final test; fully equipped laboratory, 1 to 10,000 instruments speedily and efficiently executed.—E. A. Porritt, 13 & 27, Wastdale Rd., Forest Hill, S.E.25. Tel. 1292-3. [8024]

DRAWING and tracing work for radio and electrical engineering, jig and tool and light engineering, photoprinting; full sets of drawings undertaken to commercial or Military standards.—Drawing & Tracing, Ltd., 456a, Ewell Rd., Tolworth, Surbiton. Phone Elm. bridge 7406. [7703]

TELEVISION aerial installations and aerial maintenance, full range of antennas supplied and/or installed by experts; removals and re-erections arranged; our pre-war Trade Service Dept. is now open.—Brochures from Wolsley Television, Ltd., 87, Brixton Hill, S.W.2. Tulse Hill 1240. [7320]

BUSINESSES FOR SALE OR WANTED
RADIO, elec., main road, north-west market town, extremely remunerative servicing business fully equipped with latest test equipment and battery charging plant, ideal for serviceman wanting own business; genuine ill-health cause of sale.—Box 1405 [8048]
RADIO and electrical, excellent position N.W. London, scope for increased trade, low rent, partners proceeding overseas; £300 s.a.v. sup.—Box 2034. [8176]

PALMERS Green: Radio, television, everything electrical, showroom in good-class residential area and on main road, electrical contractors; 19-year lease at £192 p.a., turnover approx. £15,000 p.a.; price £3,500, s.a.v.—Sole agent, H. R. Tennant, 30, Bruton St., W.1. [8153]

SITUATIONS VACANT
FOREMAN required to take charge of mica condenser assembly department of a factory in the London area.—Write, stating age, experience and present salary, Box 2208.

REPRESENTATIVE required by loudspeaker manufacturers for Manchester and North Midlands area, also for London area; state experience and remuneration req.—Box 2018.

RADIO cabinet designer required for large North London company, previous experience essential.—Write full details to R.C.I.D., Box 0/5441, A.K. Advge., 212a, Shaftesbury Ave., W.C.2. [7968]

SERVICE mechanics experienced in radio, S required for the West End of London.—Apply Box 2027. [8157]

HILL & CHURCHILL LTD.
BOOKSELLERS
SWANAGE, DORSET.
Available from Stock:—
Fink " Radar Engineering " - - - 35/-
M.I.T. " Principles of Radar " - - - 25/-
" Motion Picture Sound Engineering " - - - 30/-
Maxfield & Benedict. " Theory of Gaseous Conduction and Electronics " - - - 27/6
Brillouin " Wave Propagation in Periodic Structures " - - - 20/-
Smith " Applied Mathematics for Radio and Communication Engineers " - - - 17/6
Wellman " Elementary Radio Servicing " 21/-
Keen " Wireless Direction Finding " 45/-
Postage extra.
We have a large selection of English and American Books on RADIO and TELECOMMUNICATION
CATALOGUE ON APPLICATION

BATTERY CHARGERS and TRICKLE CHARGERS
Trouble-free Chargers fitted with selenium all-metal rectification. Good allowance on your old charger. Thirty years experience behind every Runbaken product. Booklet R.15 describing 12 Models. on request.
RUNBAKEN-MANCHESTER 1

THIS—Does these
ACCURATELY and QUICKLY Chassis, Brackets, Shrouds, Condenser and Transformer clips—**TREPPANING** Steel or Aluminium. Five sizes—12" to 36". Full particulars from **A. A. TOOLS, (W),** 197a, WHITEACRE ROAD ASHTON-UNDER-LYNE

TRANSFORMERS & COILS TO SPECIFICATION.
MANUFACTURED OR REWOUND
JOHN FACTOR LTD., (Formerly Stanley Cattell Ltd.), 9-11 East Street, TORQUAY, Devon 'Phone: Torquay 2162.

POST-WAR TELEVISION
The advance in Radio Technique offers unlimited opportunities of high pay and secure posts for those Radio Engineers who have had the foresight to become technically qualified. How you can do this quickly and easily in your spare time is fully explained in our unique handbook.
Full details are given of A.M.I.E.E., A.M.Brit.I.R.E., City & Guilds Exams., and particulars of up-to-date courses in Wireless Engineering, Radio Servicing, Short Waves, Television, Mathematics, etc., etc.
We Guarantee "NO PASS—NO FEE"
Prepare for to-morrow's opportunities and post-war competition by sending for your copy of this very informative 112-page guide NOW—FREE.
BRITISH INSTITUTE OF ENGINEERING TECHNOLOGY (Dept. 388)
17, Stratford Place, London, W.1



& SONS (WV) 246, High St., Harlesden, N.W.10

RADIO VALVES: British and American, from 5/10. All at official List Prices, not increased since 1940. BRIMAR.—126, 5R/250A, 6B6, 6K6, 6K7, 6S37, 6SN7, 6T7, 6V6, 7H5, 7B7, 7H8, 7C6, 7D5, 7Y4, 812, 8D2, 10D1, 11D5, 11D6, 12SR7, 25Z4, 15D2, 812, 8D2, 10D1, 11D5, 11D6, 12SR7, 25Z4, 15D2. COSSOR. 4TPB, 5T7, 183A, 41MP, 41MP7, 42-OT-DD, 42PFB, 303TH, 210DG, 210LF, 2200T, 220P, 220FA, 807, DD14, MP/PEN, MS/PEN, MS/PEN B, MV5/PEN, OM4, OM6, OM9, PT10, 13V1A, 41M1D, 41STH, 42PFB, 202VPB, 210DDT, 2158G, 400PPT, 2P, 202VP.

THIS MONTH'S SPECIALS: Flikodisk, ohm's Law Calculator, 7/6. Avo All Wave Oscillator, Mains Model, £13. Speaker fabric, square foot, 3/-.

J. BULL & SONS (WV), 246, High Street, Harlesden, N.W.10

"TELECRAFT" FIELD COILS SOUNDLY CONSTRUCTED SPEAKER FIELD COILS AVAILABLE EX STOCK. ALL POPULAR RESISTANCES UP TO 2,500 ohms. ONE SIZE 8/6 HEIGHT .28" DIAMETER 2 1/2" ONLY POLE . . . 1" OBTAINABLE FROM YOUR DEALER. SOUTHERN TRADE SERVICES LTD. 297 299, HIGH ST., CROYDON.

THE following vacancies exist in a South London firm: (A) RADIO ENGINEER capable of design of audio-frequency equipment, knowledge of high-power amplification essential, experience of acoustic problems desirable. (B) ENGINEER for maintenance of all laboratory test gear and calibration of all meters, knowledge of bridge measurements desirable. (C) ELECTRICAL tester for routine production testing of electronic equipment, experience in fault-finding essential; if capabilities warrant suitable applicant would be given charge of section. (D) PANEL wiremen (or women) capable of working directly from theoretical circuit diagrams. APPLY, giving particulars of age, experience, qualifications and salary required, to Box 2149. TELEVISION and radio service engineer, T. Catford; state experience.—Box 2142. THE AIR MINISTRY has vacancies for the following trades: Radar mechanics (air); radar mechanics (ground); wireless mechanic; wireless operator mechanic; wireless electrical mechanic; wireless operator; wireless teleprinter operator; teleprinter operator. Preference will be given to former R.A.F. instructors and tradesmen and any other ex-Servicemen possessing the requisite experience. The posts available are at the R.F. Radio Schools at Compton Bassett and Yalesbury in Wiltshire, at Cranwell, Lincs, and Hedgesford, Staffs. Successful applicants will be engaged on a temporary non-pensionable basis only, but will be guaranteed employment for 3 years subject (after a probationary period of 3 months) to efficiency and conduct being satisfactory. Inducive rates of pay are as follows: Civilian instructor, Class I, £400-£415-£460 per annum; civilian instructor, Class II, £350-£415-£410 per annum. Application should be made at the Appointments or Local Offices of the Ministry of Labour and National Service, from whom further particulars may be obtained. [8112] SERVICE Supervisor, with previous experience of radio servicing, required for West End of London area—Apply Box 2199. [8213] DEAF aid service mechanic required for leading West End manufacturers; good wages, good hours for reliable man.—Write Box 2148. [8196] EXPERIENCED storekeeper required for old established radio manufacturers, South London area.—Write, stating age, experience and salary required, to Box 1735. [8121] RADIO testers required for alignment and fault-finding superhet receivers; previous experience essential.—Acc Radio, Ltd., Tower Rtd., Willesden, N.W.10. Wil. 3904. [7951] CHIEF engineer required with great exp. in commercial receivers and television; first-class references necessary; excellent position offered in a known London radio factory; salary approximately £1,000 p.a.—Box 355. DRAUGHTSMEN required for development and jig and tool D.O.s, familiar with electronic equipment construction, Oldham area.—Apply, giving full particulars of experience, qualifications and salary required to Box 2020. RADIO development engineer (senior), salary £450 to £600 p.a., required by modern radio manufacturers in West London area; preference given if experienced in receiver design work.—Write full details to Box 2026. SERVICE department manager, must be fully conversant with all makes of radio receivers and television, pre-war experience an advantage; £8/10 to £9/10 per week, and bonus, according to qualifications. WYCOMBE ELECTRICAL SUPPLIES, Ltd., 51-52, Oxford St., High Wycombe, Bucks, Tel. H.W. 457. [8125] DEVELOPMENT and research engineer required by radio manufacturers, S.E. London district, with commercial, radio and television experience.—Apply in strict confidence, stating age, qualifications, exp., Box 1396. THE DECCA NAVIGATOR Co., Ltd., require a development engineer for design and layout of mobile and static ground transmitting stations; previous experience essential; salary will be based on qualifications and experience.—Applications in the first instance should be in writing, address The Decca Navigator Co., Ltd., 1-3, Brixton Rd., London, S.W.9. Please quote reference S.E. [8203] IMPORTANT group of companies entering new field requires the service of a fully qualified radio receiver designer; applicants must have experience in the latest technique in short-wave communication receiver design.—Apply Box 2029. [8164] COIL room supervisor required by radio manufacturer, experience R.F. coils, winding and light assembly work essential, knowledge coil test an advantage, opportunity if willing to learn conveyor assembly, good salary and prospects for right man.—Write full particulars, exp., salary reqd., Box 2021. [8144]



CIRCUIT No. 20 10 valves, 6 wave-bands, 12 watts (undistorted) Output Superheterodyne Receiver

Owing to the excellent reports we have received of the above we are devoting our space this month to another description of it. Constructed from our Blue print No. 20. Brief specification. R.F. stage of Amplification using 6 (K7, H.F. Pen.), the gain of which is controlled, followed by P.C. Triode Hexode 6K8 followed by I.F. Amp. stage 6K7 feeding into a double diode triode 6Q7 for L.F. Amp. and 2nd detector and noise limiter, followed by Phase inverter feeding 2-6V6 or 2-6L6 in push pull. Rectifier valve 5U4G. Visual tuning indicator (Magic eye EM34). The coil unit.—The coil unit consists of 18 high "Q" iron cored coils, 6 each in R.F., H.F. and Osc. stages, all nidget type, designed especially for us. 20 Ceramic trimmers and 3 bank switch, with shorting plates.

A.V.C. is used on all wave-bands with a switch for cutting out when not required. The coil unit is completely screened by 18 s.w.g. aluminium. The output transformer is of multi-ratio type mounted under the chassis. Controls R.F. gain, 6 wave-band coil switch, A.V.C. on/off radio-gram switch, noise limiter, tone-control, Audio gain and mains on/off. Provision for B.F.O. on/off if required.

3 gang tuning condenser Ceranic insulation, rubber mounted. All H.F. valves screened by aluminium cans. Double ratio slow motion drive and 6 wave band dial glass covered Chassis 16 swg Aluminium, ready drilled 12 1/2 x 7 1/2 x 4.

3 Fuses fitted 2 in mains supply and 1 in rectifier circuit.

Provision for dipole Aerial and extension speaker P.U. sockets.

This set is noted for its fine quality of reproduction on radio and gram. We have received much appreciation and congratulations from customers on its performance. A demonstration model is available at our premises at 307 High Holborn.

FULL SIZE BLUE PRINTS (2 practical and 1 theoretical) and priced list of components 5/-. Any component may be purchased separately.

307 HIGH HOLBORN LONDON W.C.1. Phone: HOLborn 4631



Stand 323 in the NATIONAL HALL GALLERY where it will be relatively peaceful and quiet

THE LOWTHER MANUFACTURING CO. Lowther House, St. Mark's Road, BROMLEY, KENT. Rav. 5225

HARTLEY-TURNER HIGHEST FIDELITY SERVICE

Although new projects are made very difficult in this crazy country of ours, we are working hard to get our programme completed before the autumn. All who have written to us will get full information as soon as possible. Others, who have not yet contacted us will find their high-fidelity troubles finished when they "sign-up" with Hartley-Turner. We founded the high-fidelity industry, and we still lead it.

If you visit us for a demonstration we don't ask you to buy—we leave you to convince yourself you cannot do without the

HARTLEY-TURNER SPEAKER MODEL 215 at £9
6/6 post and packing; 5/- returned on carton.

H. A. HARTLEY CO. LTD.
152 HAMMERSMITH RD., LONDON, W.6
TELEPHONE: RIVERSIDE 7.87
R.F.L.P.30

"ENGINEERING OPPORTUNITIES"



This unique handbook shows the easy way to secure A.M.I. Mech. E., A.M.Brit.I.R.E., A.M.I.E.E., City and Guilds, etc.

WE GUARANTEE—
"NO PASS—NO FEE."
Details are given of over 150 Diploma courses in all branches of Civil, Mech., Elec., Motor, Aero., Radio, Television and Production Engineering, Tracing, Building, Govt. Employment, R.A.F. Maths., Matriculation, etc.

Safeguard your future; send for your copy at once—FREE.
B.I.E.T., 387, SHAKESPEARE HOUSE,
17, STRATFORD PLACE, LONDON, W.1.

ASSISTANT required for retail business in W.C. London area; trade experience and sales ability essential; would be required to take charge and develop "Ham" side of business.—Write, stating experience, wage required, etc., to Box 2231. [6265]

TEST gear superintendent required for expanding radio component factory, suburban, Surrey; qualifications, degree or equivalent, previous experience in mechanized testing desirable; salary £500 upwards, according to qualifications and experience.—Box 2146.

CARRIER telephony development engineer required, Manchester area, for work on centemetric carrier telephony equipment; salary £550 to £650 p.a., according to qualifications.—Reply, giving full particulars, to Coscor Radio, Ltd., Chadderton, Nr. Oldham.

LARGE organization in West Middlesex requires field service and workshop engineers with good television and radio technical knowledge; smart appearance, car, an advantage, but not essential.—Reply, stating details past exp., age and salary reqd., Box 2145.

SENIOR draughtsman required, for company engaged in light current electrical measuring equipment and X-ray apparatus, radio experience desirable; basic starting salary up to £7/5 per week according to experience and ability, exclusive of cost of living bonus (at present 25%).—Write Box 2047. [8105]

ELECTRICAL and radio engineer required for training as specialist in interference suppression with qualifications not lower than City and Guilds grade 2; work would be from North London office and ownership of car an advantage, age should be between 25-35.—Applicants to state education, age and experience in full, to Box 2025. [8151]

RADIO engineering company in South London requires engineer to take charge of test department specializing in radio navigational equipment; applicants must be able to prove they have first class technical qualifications combined with considerable experience in similar work; position offers good opportunities to the right man.—Full details to Box 7429.

E.M.I. RESEARCH LABORATORIES, Ltd., have vacancies for qualified research engineers with experience in the design and development of: (a) High frequency transmitters; (b) transmitting aerial systems; (c) radar equipment; (d) electric-acoustic equipment. Applications, giving full particulars of qualifications and experience, together with salary expected, should be addressed to Personnel Manager, Gramophone Co., Ltd., Hayes, Middlesex.

ASSISTANT wanted for valve test group to work on design and planning of specialized test equipment; must have good knowledge and experience of small transmitting, receiving and rectifier valves and their circuits, age preferably 25-30.—Apply by letter only, stating age, qualifications and experience, to the Director, Research Laboratories of the General Electric Co. Ltd., Wembley, Middx.

MECHANICAL designers, age 30-40, capable of completing mechanical design of fixed or mobile transmitters to electrical information supplied, supervising detail drawings, preparation of stock lists and purchasing specifications; location South-West London.—Write, stating age, experience, salary required and when free to commence, to Group Staff Officer (31) Philips Lamco, Ltd., Century House, Shaftesbury Av., London, W.C.2

BRITISH OVERSEAS AIRWAYS CORPORATION have vacancies for ground radio operators, medically fit and willing to serve on a world-wide basis overseas. The upper age limit is 40 and preference will be given to single men. Basic rate of pay £5/15 to £6/10 a week, plus allowances overseas graded according to the local standard and cost of living. The initial tour of duty is three years, and successful candidates will be required to serve in any part of the world at the discretion of the Corporation. Essential qualifications: Postmaster-General's First or Second-class Certificate or equivalent service experience. Candidates not holding certificates will be given proficiency tests on ground radio operating. Applications in writing to Staff Appointments Superintendent, Stratton House, Piccadilly, W.1, stating age, certificates held and giving brief details of radio operating experience. Replies will be sent only to candidates called for interview. Mark envelopes "Ground Radio Operator." [7960]

UNIVERSITY College of Swansea.—The Council of the College invites applications for the post of laboratory assistant in the Department of Engineering, who will be required to act as steward in the engineering laboratories; experience in radio construction work would be an advantage; wages £5 per week, rising by annual increments of 5/- per week to a maximum weekly wage of £6.—Applications (stating age and experience), together with copies of two recent testimonials, should be forwarded to the Registrar, University College, Singleton Park, Swansea. [8146]

L-R-S DELIVERY from STOCK

- AVOMETER Model 7 ... £19 10 0
(Carr. and packing 2/6 extra)
- Avomitor DC Test Meters* ... 4 Gns
- Avomitor AC/DC Test Meters* ... £8 10 0
- *Plus 1/- Regd. post and supplied on Easy Terms if desired.
- Stuart Centrifugal Electric Pumps
(for all pumping purposes, garden fountains, etc.)
- No. 10. 100 galls. p.h. ... £5 10 6
- No. 11. 300 ... £6 16 0
- Inc. foot valve and strainer, carr. paid. STUART adjustable fountain jet, 5/3.
- Morphy Richards Cydon Door Chimes ... 49/6
Post Free.
- THE LONDON RADIO SUPPLY CO.**
(The L.R. Supply Co. Ltd.) Est. 1925
BALCOMBE SUSSEX

THE COIL PICKUP

Justifies a Good Amplifier

Wilkins & Wright Ltd., Holyhead Road, Birmingham 21.

Our original post-war plans have met many man-made setbacks.

REVISED PLANS are evolving. Please don't write, phone, or call. We will advise when ready.



VOIGT PATENTS LTD.

THE NORTHERN POLYTECHNIC HOLLOWAY ROAD, N.7.

Principal: T. J. DRAKELEY D.Sc., Ph.D., F.R.I.C., F.I.R.I.

Department of Radio and Musical Instrument Technology.

Head of Department:
S. A. Hurren, M.C., M.Brit.I.R.E.

Full-time Day Courses in RADIO TECHNOLOGY

in preparation for all recognised qualifications in this subject. Practical laboratory and workshop experience provided.
Prospectus free on application to Secretary
New Term begins September 22nd.

EDDYSTONE '640'

We are now booking orders for this first-class communications receiver. Demonstration model on view at our Show Room.

EDDYSTONE '504' in stock.
52 Page Catalogue of Components & Accessories 1/- Post Paid.

B.T.S.

The Radio Firm of the South,
63, London Road, Brighton 1,
Sussex.

COVENTRY— RADIO

COMPONENT SPECIALISTS SINCE 1925

NOW READY

THE LATEST CIRCUIT AND DETAILS OF THE 5-VALVE "NAPP" SUPER-HET, 3 WAVE-BAND A.C. AND A.C./D.C. MAINS RECEIVER. PRICE 6d. POST PAID

Latest List of Components, 3d.

COVENTRY RADIO,
191, DUNSTABLE ROAD, LUTON

MORSE CODE TRAINING



There are Candler Morse Code Courses for **BEGINNERS AND OPERATORS.**

Send for this Free "BOOK OF FACTS" It gives full details concerning all Courses.

THE CANDLER SYSTEM CO.,
(Room 55W), 121 Kingsway, London, W.C.2
Candler System Co., Denver Colorado, U.S.A.
NOTE.—From AUG 2nd to 11th. London Office CLOSED

MINISTRY OF CIVIL AVIATION. Appointment of radio mechanics, grade II. **APPLICATIONS** are invited for appointment as radio mechanics, grade II, at Civil Aviator radio stations in the United Kingdom. Candidates must be at least 21 years of age and possess a knowledge of the fundamental principles of radio and radar with a general knowledge of one or more of the following radio aids for navigation: Direction finding, Loran, Gee, radar beacons, A.C.R. or G.C.A. They should also have had practical experience in the use of tools, filing, drilling, hard and soft soldering, cabling and wiring and be experienced in the use of electrical and radio measuring instruments including cathode ray oscilloscopes. The possession of City and Guilds Certificates in Radio Communication and Technical Electricity will be an advantage. The pay will be 115/- per week, inclusive, rising by annual increments of 3/- a week to a maximum of 130/- a week.—Applications, which must be in writing, stating date of birth, full details of qualifications and experience and quoting the reference C.A. Est/RM should be addressed to the Establishment Division, Ministry of Civil Aviation, 10, Fleet St., London, E.C.4. [8140]

SITUATIONS WANTED

EMPLOYMENT in London desired experience electrical installations, appliances, radios, cinema, office and export; travelled, linguist.—Box 2204. [8215]

EX-R.A.F. navigator (26), final C. and G. radio comm. 2 years' experience television development, requires interesting job with real prospects, here or on Continent.—Box 2227. [8245]

A.M.I.E.E., A.M.Brit.I.R.E. (32), desires high executive position in light electrical industry, preferably overseas. 12 years' experience all phases administration, production, design.—Box 2153. [8209]

EXECUTIVE sales and production, 33 yrs., with wide experience radio electronics based upon sound technical knowledge, experienced all works depts., requires post, preference for Australia.—Box 2230. [8258]

ENGINEER, electrical, radar, radio, 9 years Western Electric sound, 5 years commissioned rank in R.A.F. Technical (Sigs.) Radar Branch, seeks position as technical representative, sales engineer, or in development, good mathematician, excellent personality, world travelled; highest references.—Write Box 2013.

WORKS manager of small radio and electrical company requires change. University trained, 2 yrs. radio research labs., 6 yrs. radio technical officer, now handling design, buying, production, costing, sales, capable of carrying a job from drawing board to showroom; salary £650-£750.—12h, Uxbridge Rd., Kingston, Surrey. [8118]

ELECTRONIC engineer, C. and G., I and II, desires change, preferably in South of England; at present engaged on R.F. heating design and construction; fully conversant all types radio transmitters, including C.E. valves. 5 years' experience civilian radio service. 5 years Radar mechanic, R.A.F.; willing to travel anywhere and possess own car.—Box 2229.

TUITION

THE Institute of Practical Radio Engineers have available Home Study Courses covering elementary, theoretical, mathematical, practical and laboratory tuition in radio and television engineering; the text is suitable coaching matter for I.P.R.E. Service entry and progressive exams.; tuition fees at pre-arranged rates are moderate.—The Syllabus of Instructional Text may be obtained, post free, from the Secretary, 20, Fairfield Rd., Crouch End, N.8. [6722]



AN AC/DC five valve Superhet Two Wave-Band Receiver for 200-250 volt mains...

Of striking appearance in attractive two-colour plastic cabinet, with unique illuminated translucent dial and novel tuning mechanism to combine slow and accurate tuning with fast band search (5 tuned circuits).

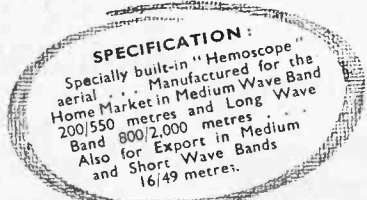

£13.13.0 Plus Purchase Tax £3.3.8.

in maroon, red, white or pastel shades of blue, pink, green, 7s. extra. Plus 1/9 P. Tax. Guaranteed.

CHAMPION ELECTRIC CORPORATION CHAMPION WORKS, SEAFORD, SUSSEX

Tel. No.: SEAFORD 3235

Export Agents:

Geo. Vint & Co. Ltd., 124, Seymour Pl., London, W.1.

THE British National Radio School

OFFERS you a career. **WRITE** to-day for free booklet describing our wide range of training courses in radio, Radar, telecommunications, principles, mathematics, physics, and mechanics; correspondence and day classes for the new series of C. & G. examinations; we specialise in turning operators into engineers, and for this purpose our "Four Year Plan" (leading to A.M.I.E.E. and A.M.Brit.I.R.E., with G. Certificates as interim rewards) surpassed; our guarantee has no strings attached.—Studies Director, B.Sc., A.M.I.E.E., M. Brit. I.R.E., 66, Addiscombe Rd., Croydon, Surrey. [6811]

RADIO Engineering, Television and Wireless Telegraphy, comprehensive postal courses of instruction.—Apply British School of Telegraphy, Ltd., 179, Clapham Rd., London, S.W.9 (Estd. 1906). Also instruction at school in wireless for H.M. Merchant Navy and R.A.F. [9249]

ENGINEERING careers and qualifications. **BOTH** Government and industry have announced and emphasised that young men with technical knowledge and qualifications must receive every chance to rise to the highest positions within their capacity, in post-war engineering and allied industry; write to-day for "The Engineer's Guide to Success"—200 courses free—which shows you how you can become A.M.I.E.E., A.M.I.E.E., A.M.I.Mech.E., A.F.R.Ae.S., etc., and covers all branches in radio, automobile, mechanical, electrical, production, aeronautical, etc. **THE Technological Institute of Great Britain**, 82, Temple Bar House, London, E.C.4. [4918]

UNIVERSITY COLLEGE, Southampton.—Diploma in Electronics. An advanced course of Honours Degree Standard covering the entire field of electronics, with special emphasis on receiver design and line technique, will commence on 6th October, 1947.

THE course will be full-time for one academic year. The College will grant a diploma by examination to students who successfully complete the course. Entry qualification is normally a University degree or its equivalent. There are still four vacancies for this course. Further details may be obtained from the Registrar.

RADIO training—P.M.G. exams. and I.E.E. Diploma; prospectus free.—Technical College, Hull. [0611]

A.M.I.E.E. examinations.—Qualified electrical engineer-lecturer (B.Sc. (Eng.) Hons. A.M.I.E.E.), specializes in private individual tuition, vacancies for April, 1948, or later exams.; personal or correspondence.—Box 407.

ENGINEERING opportunities.—Have you had your copy of this free guide to A.M.I.Mech.E., A.M.I.E.E., and all branches of engineering, building and plastics? Become technically trained on no pass—no fee* terms for higher pay and security.—For free copy write B.I.E.T. (Dept. 387B) 17, Stratford Place, London, W.1. [6939]

TECHNICAL TRAINING A.M.I.E.E., City and Guilds, etc. on "No Pass—No Fee" terms; over 95% successes; for full details of modern courses in all branches of electrical technology send for our 112-page handbook, free and post free.—B.I.E.T. (Dept. 388A), 17, Stratford Place, London, W.1. [6270]

BOOKS, INSTRUCTIONS, ETC. **WEBB'S** radio map of the world locates any station heard, size 40x30in, 4/6, post 6d.; on linen, 10/6, post free.—Webb's Radio, 14, Soho St., W.1. Gerrard 2089. [9947]

WALTER SWITCHES ARE MADE FOR



WALTER INSTRUMENTS, LTD.

GARTH RD., LOWER MORDEN, SURREY DERWENT 4421. Grams: WALINST, MORDEN, SURREY

C. R. Casson Ltd

STABLE to **carbon resistor**



Resistors produced by the cracked carbon process remain stable to $\pm 1\%$ of initial value.

★Tolerance $\pm 1\%$
 $\pm 2\%$ $\pm 5\%$

Low temperature co-efficient.

Welwyn carbon resistor

WELWYN ELECTRICAL LABORATORIES LTD.
Welwyn Garden City, Herts. Telephone: Welwyn Garden 38168.

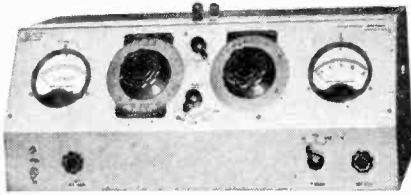

COIL ANALYSER MODEL QL100

Here is one of the many of our High Grade Instruments

"Made to Measure"

An entirely original design enabling the direct measurement of Q, Inductance and Self-Capacity at radio-frequency. This is but one of our many instruments of pioneer design for communication engineering. If you have any special problem do not hesitate to make use of our team of experts.

BRITISH PHYSICAL LABORATORIES

Note New address

**HOUSEBOAT WORKS,
RADLETT, HERTS.**

**RESERVE YOURS NOW
THE 'Q-MAX' B4/40 TRANSMITTER**

PRICE

£75

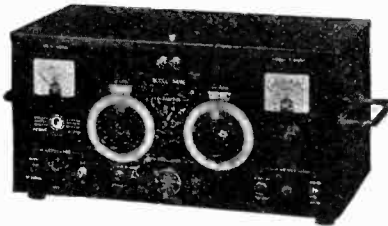

A Complete 40 watt—Four Band Transmitter for Phone or C.W.

- ★ Four Bands 80-40-20-10 meters at the turn of a single switch
- ★ Two Tuning Controls only.
- ★ Forty watts C. W. Thirtyfive watts Phone to KT8C Final
- ★ Built-in Modulator and Power Pack.
- ★ High efficiency Four-band Tank Coil Turret.
- ★ All essential circuits metered.
- ★ Provision for low impedance input from a V.F.O.
- ★ Instant Crystal changing from front of panel.
- ★ The whole completely housed in attractive black crackle-finished steel cabinet 19" x 10" x 9 1/2"

NOTHING EXTERNAL EXCEPT MICROPHONE AND KEY

BERRY'S
(SHORT WAVE) LTD

25, HIGH HOLBORN, LONDON, W.C.1
(OPP. CHANCERY LANE) Tel.: HOLBORN 6231

R&A
BRITAIN'S FOREMOST REPRODUCERS

Reproducers and Amplifiers Ltd.,
WOLVERHAMPTON,
ENGLAND.

AN EXTENSIVE RANGE OF HIGH GRADE TRANSFORMERS

- MAINS TRANSFORMERS 60 and 100 watt, 350-0-350v, 0-4-5v, 0-4-6.3v. Totally enclosed in Metal Shell.
- UNIVERSAL OUTPUT TRANSFORMERS. Suitable for Triode, Pentode, Class B and Q.P.R. Output Stages Fully Tropicalised.
- PRECISION TRANSFORMERS AND CHOKES (LAB RANGE.) Transformers and chokes in this range are precision built components with a guaranteed tolerance of 2% of rated values. First Grade Material; only are used in their manufacture. Lab range components can be made to individual specifications or supplied from our comprehensive Catalogue.



**RECORDER HOUSE,
48-50, GEORGE STREET,
PORTMAN SQUARE,
LONDON, W.1**

Cables: SIMSALE, LONDON.

Telegrams: SIMSALE, WESDO, LONDON.

"You're CERTAIN to get it at ARTHURS!"

VALVES: We have probably the largest stock of valves in the country.

AVOMETERS:

AVOMETER, Model 7	£19 10 0
AVOMETER, Model 40	£17 10 0
VALVE TESTER (Complete).....	£16 10 0
TEST BRIDGE	£11 0 0
AVOMINOR, Universal Mod.	£8 10 0
SIGNAL GENERATORS	£13 0 0

TAYLORS' METERS. NOW IN STOCK.

LONDON'S OLDEST LEADING RADIO DEALERS

Only Address

GRAY HOUSE, 150, CHARING CROSS ROAD, LONDON, W.C.2

Telephone: TEMple Bar 5833/4



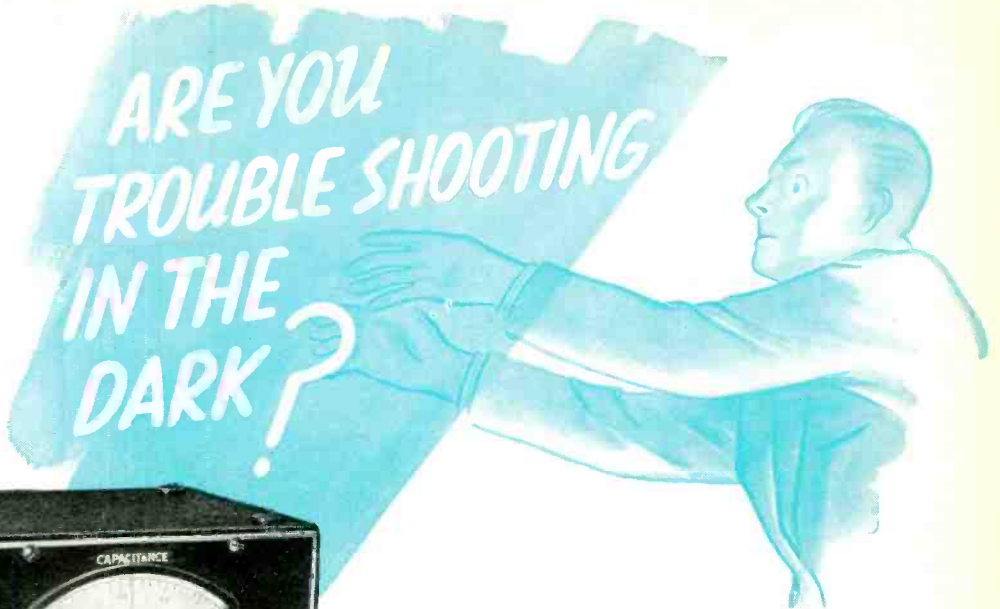

Groping and rule of thumb methods are out of date — the times call for accuracy and speed in servicing.

Have the facts given to you simply with this complete instrument — for which you will find a use at every turn of your day-to-day work. The Hunt Capacitance and Resistance Analyser is a high grade precision instrument developed by specialists in Capacitor design and manufacture — hence it is practical in conception and complete in application, a master instrument in every respect.

MEASURES capacity, power factor, resistance, insulation resistance. **DETECTS** defective capacitors. **TESTS** continuity, etc.

One dial reading without charts or graphs. Complete — no headphones, external meters or similar accessories required. Robust and extremely portable. Rating: 210-250 v. A.C. 50 cycles.

Dimensions: 6½" x 9½" x 5"

List Price **£18.18.0**

HUNTS

CAPACITORS

TRADE MARK

CAPACITANCE & RESISTANCE ANALYSER

A · H · HUNT LTD · LONDON · S.W.18 · ESTABLISHED 1901

RADIOLYMPIA · STAND No. 88. GRAND HALL · OCT. 1-11

3 REASONS WHY ERSIN MULTICORE IS

The Finest Cored Solder in the World

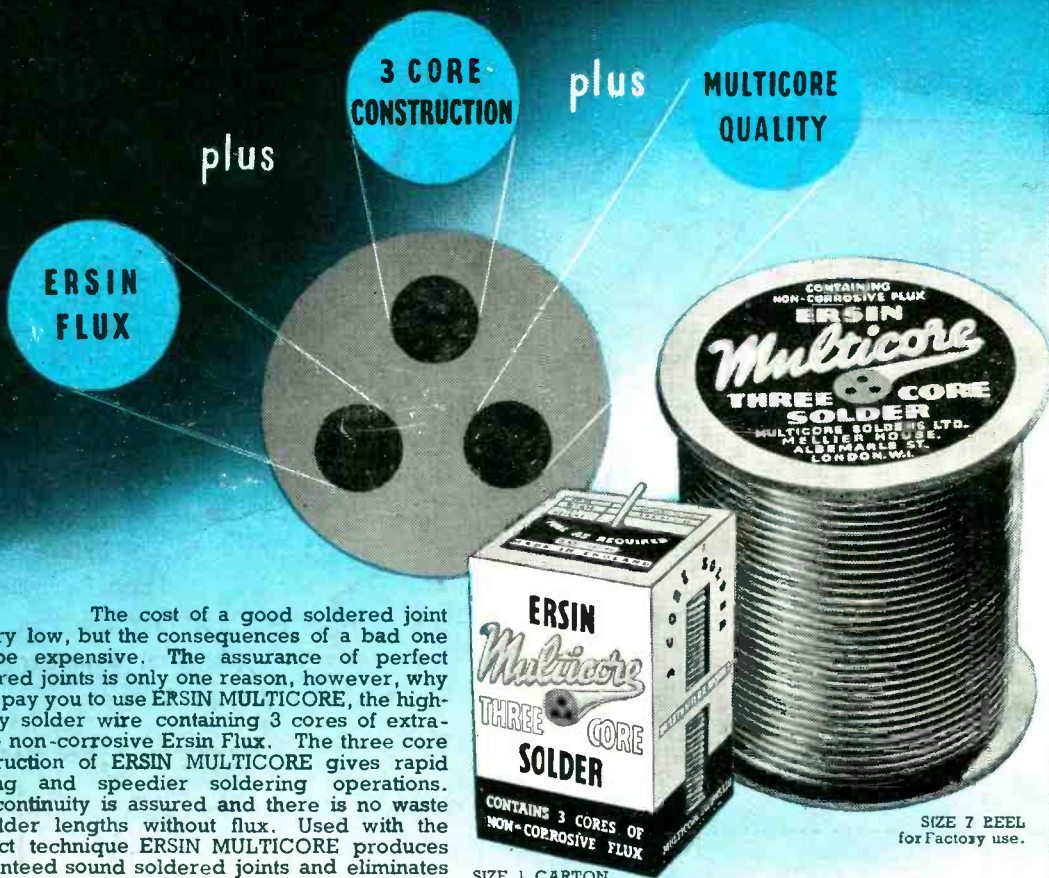

The cost of a good soldered joint is very low, but the consequences of a bad one can be expensive. The assurance of perfect soldered joints is only one reason, however, why it will pay you to use ERSIN MULTICORE, the high-quality solder wire containing 3 cores of extra-active non-corrosive Ersin Flux. The three core construction of ERSIN MULTICORE gives rapid melting and speedier soldering operations. Flux continuity is assured and there is no waste of solder lengths without flux. Used with the correct technique ERSIN MULTICORE produces guaranteed sound soldered joints and eliminates 'dry' or H.R. joints.

SIZE 1 CARTON
For Service Engineers and Workshops.

SIZE 7 REEL
for Factory use.

PRICES SIZE 1 CARTONS.

Catalogue Ref. No.	Alloy Tin/Lead	S.W.G.	Approx. length per carton.	List price per carton (subject)	
				s.	d.
C 16014	60/40	14	44 feet	6	0
C 16018	60/40	18	114 feet	6	9
C 14013	40/60	13	27 feet	4	10
C 14016	40/60	16	60 feet	5	3

Combining high-speed precision soldering with economy in use, ERSIN MULTICORE is preferred by most Radio and Service Engineers as well as by leading manufacturers of radio and electrical equipment. Manufacturers and Service Engineers are invited to write for technical information and samples.

MULTICORE SOLDERS LTD., MELLIER HOUSE, ALBEMARLE ST., LONDON, W.1. Tel.: REGent 1411